

18.06.2012
GZ: BA 55-QIN 5003-2010/0006 (Bitte stets angeben)

Fuller risk factor approach

A proposal for its further specification

Working paper

The Basel Committee on Banking Supervision issued a consultative document (the "consultation paper", CP) on the fundamental review of the trading book.¹ This discussion paper includes two proposals for a revised standardised approach. The Committee proposes the "partial risk factor" approach. It also invites feedback on a "fuller risk factor" approach as an alternative. It states: "The differences in capital required, and determination of credibility as a fallback device, by the two approaches can only be assessed when both approaches are calibrated ..."

Stakeholders have asked for more information inter alia on the specifics of the fuller risk factor approach. To meet such requests BaFin publishes this working paper. It describes its proposal for the further specification of the fuller risk factor approach. (Henceforth: "the proposal") In particular, the proposal includes a formal description of the capital charge, including when the portfolio includes non-linear instruments (e.g. options) as well. The working paper also outlines the treatment of credit risk, and worked examples for an equity option and interest-related instruments. At this point we are not aware of initiatives for an alternative specification of the fuller risk factors approach.²

As the consultation is already under way, this document has not been submitted to the Basel Committee for approval. Interested parties that would like to provide feedback that relates specifically to this proposal are invited to direct this to: BA55@bafin.de by 7 September 2012.

Bankenaufsicht

Hausanschrift:
Bundesanstalt für
Finanzdienstleistungsaufsicht
Graurheindorfer Str. 108
53117 Bonn | Germany

Kontakt:
Herr Dr. Rüdiger Gebhard
Referat BA 55
Fon +49 (0)2 28 41 08-1572
Fax +49 (0)2 28 41 08-1550
BA55@bafin.de
www.bafin.de

Zentrale:
Fon +49 (0)2 28 41 08-0
Fax +49 (0)2 28 41 08-1550

Dienstsitze:
53117 Bonn
Graurheindorfer Str. 108
Georg-von-Boeselager-Str. 25

53175 Bonn
Dreizehnmorgenweg 44-48

60439 Frankfurt
Marie-Curie-Str. 24-28

¹ Available from www.bis.org.

² Helpful comments from Mr. Johannes Reeder, Mr. Christoph Baumann, and Mr. Karl Reitz are gratefully acknowledged. Mr. Frank Oertel provided helpful input for the formal description of the approach.

1. Summary

As in the case of the partial risk factor approach the proposal would be designed as a set of rules for determining the capital charges. Apart from being subject to risk-based supervisory oversight, the bank would apply these rules without any supervisory intervention. The approach is designed in particular to recognise hedging in a risk-sensitive way, for linear and non-linear instruments.

The risk factors are set up such that for each risk factor just one risk parameter has to be set: its standard deviation. This should facilitate a robust and transparent calibration.

For each of the risk factor classes of equity risk, interest rate risk, foreign exchange (FX) risk, commodity risk and credit spread risk, the bank would determine the expected shortfall (ES) for market risk by carrying out the following three-step procedure:

Step 1: The bank maps each instrument to the applicable risk factors.

Step 2: The bank determines the size of the net risk position for each risk factor.

Step 3: The bank aggregates its net risk positions across risk factors of the same risk factor class to determine a capital charge.

The capital charge for credit risk would be determined differently in a few aspects. In particular, the above three-step procedure would only apply to credit spread risk, not to default risk. Details in this respect are provided in section 4.

To determine the overall capital charge for market risk, the bank would aggregate the capital charges of all five risk factor classes (equity risk, interest rate risk, FX risk, commodity risk and credit risk) according to a variant of the regulatory aggregation scheme of the models-based approach (see formula (1) in section 4.5.6 of the CP).³

³ Where one of the risk factor classes FX or commodities is concerned, instruments from both banking and trading book have to be considered. For equity risk, credit risk and interest rate risk, only instruments belonging to the trading book are subject to a standardised approach for market risk.

Figures 1 and 2 illustrate the approach.

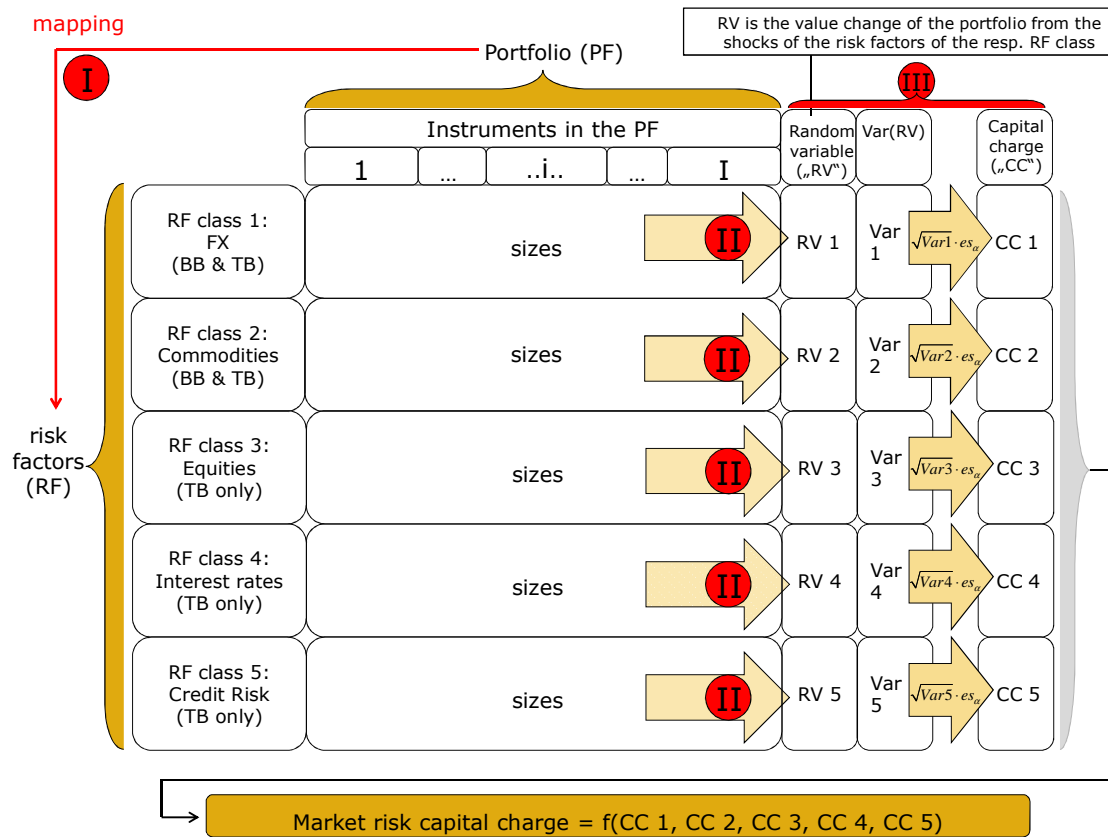

Figure 1: Overview

The Roman numbers in Figure 1 relate to the three steps for the calculation of the capital charge.

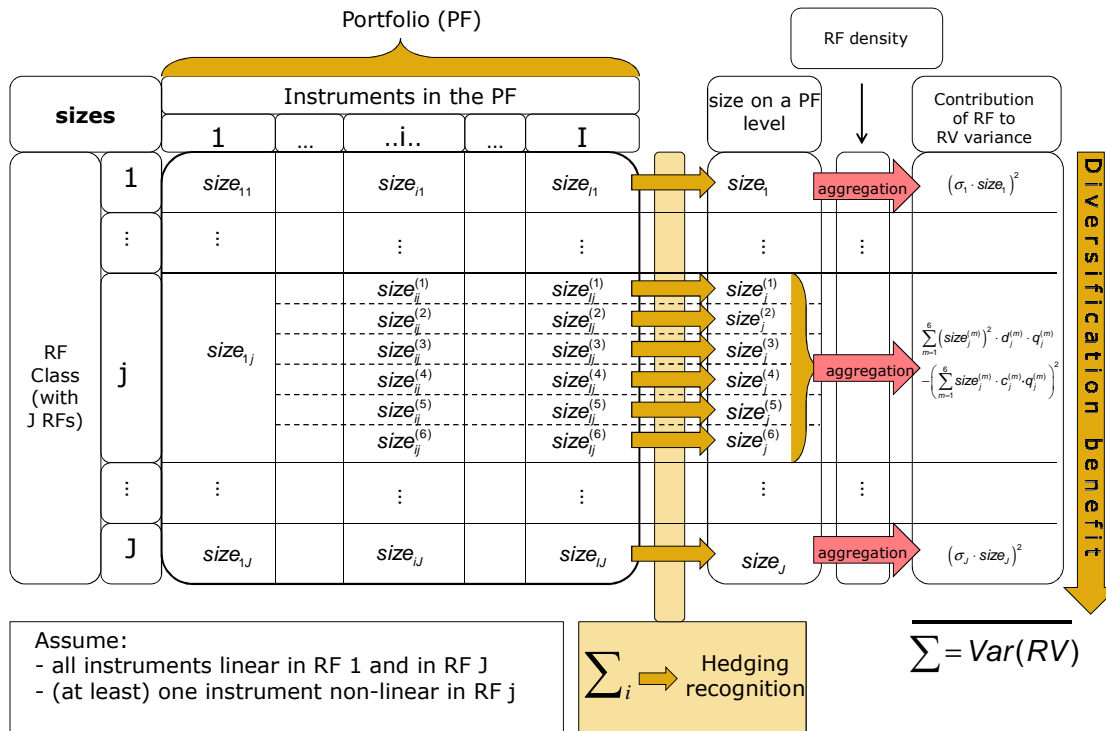

Figure 2: Capital charge for a given risk factor class.

This document is organised as follows: section 2 presents a formulaic description of the algorithm for determining the capital charge. Section 3 provides an intuitive description of the approach and highlights the rationale for key design decisions. Section 4 specifically discusses the treatment of credit risk. Annex 1 derives the formulas for the capital charge and highlights the underlying mathematical assumptions and simplifications. Annex 2 provides worked examples that illustrate the algorithm.

2. Formulaic description of the algorithm

For each of the risk factor classes equity risk, interest rate risk, FX risk and commodity risk, and for credit spread risk, the bank would determine the capital charge by approximating the expected shortfall (ES) as follows:

$$ES_{\alpha} \approx es_{\alpha} \cdot \sqrt{\sum_j \text{Var} \left(\sum_i \Delta_j MV_i (RF_j) \right)}, \quad (1)$$

where

es_{α} denotes a tail average by which the standard deviation $\sqrt{\sum_j \text{Var}(\dots)}$ of the change in value of the portfolio (the portfolio standard deviation, for short) is multiplied to determine the ES at confidence level $1 - \alpha$,

RF_j denotes the j -th risk factor,⁴ which is defined as a random shock in the form of a relative change to some pricing parameter p_j .⁵

$\Delta_j MV_i (RF_j)$ denotes the (random) change of the market value of instrument i attributed to the j -th risk factor (in units of currency of the bank's reporting currency).⁶

A capital charge for default risk would be determined as the sum of the default risk charges for "long" credit risk positions. This charge would be added to the capital charge for credit spread risk.

⁴ As is customary in statistics, we have denoted random variables using CAPITAL letters. Real numbers, and vectors of real numbers are denoted in lower case letters.

⁵ Example: The price of IBM is a pricing parameter. A random variable that shocks the price of IBM is a risk factor.

⁶ $\Delta_j MV_i (\cdot)$ is a function that transforms the random variable RF_j , ie the random variable in

$\Delta_j MV_i (RF_j)$ is RF_j . This means that for this expression we override the convention to denote random variables by capital letters. This is done to follow the notation in the CP where MV denotes a market value. Note further that ES_{α} is a real number. This follows notation employed in the CP.

Seite 6 | 76

The contribution $\text{Var}\left(\sum_i \Delta_j MV_i(RF_j)\right)$ of the j-th risk factor to the portfolio variance is approximated by:⁷

$$\text{Var}\left(\sum_i \Delta_j MV_i(RF_j)\right) \approx \sum_{m=1}^6 (\text{size}_j^{(m)})^2 \cdot d_j^{(m)} \cdot q_j^{(m)} - \left(\sum_{m=1}^6 \text{size}_j^{(m)} \cdot c_j^{(m)} \cdot q_j^{(m)}\right)^2 \quad (2)$$

The range of the potential realisations of the j-th risk factor is subdivided into m intervals $I_j^{(m)}$. $q_j^{(m)} = P(RF_j \in I_j^{(m)})$ is the probability of the event that the j-th risk factor assumes a value from the m-th interval. $c_j^{(m)} = E(RF_j | RF_j^{(m)} \in I_j^{(m)})$ is the expected value of the j-th risk factor on the condition that the j-th risk factor assumes a value from the m-th interval. $\text{size}_j^{(m)}$ denotes the change in value of the portfolio given a shift $c_j^{(m)}$ of the j-th risk factor (this is referred to as the size of the net risk position of the bank with respect to the j-th risk factor given that shift $c_j^{(m)}$). $d_j^{(m)} = E(RF_j^2 | RF_j^{(m)} \in I_j^{(m)})$ is the expected value of the squared j-th risk factor on the condition that the j-th risk factor assumes a value from the m-th interval. The parameters $q_j^{(m)}$, $c_j^{(m)}$ and $d_j^{(m)}$ reflect the density function of the j-th risk factor, including its dispersion, skewness and kurtosis.

The size of the net risk position with respect to the j-th risk factor given $c_j^{(m)}$ is

$$\text{size}_j^{(m)} = \sum_i \text{size}_{ij}^{(m)}, \quad (3)$$

i.e., the sum of the changes in value across all instruments in the portfolio to which the j-th risk factor applies, given the shift $c_j^{(m)}$. Next,

$$\text{size}_{ij}^{(m)} = \frac{MV_i\left(\left(1 + c_j^{(m)}\right) \cdot p_i\right) - MV_i(p_i)}{c_j^{(m)}}, \quad (4)$$

⁷ This uses the following formula for the variance of a random variable X:

$$\text{Var}(X) = E(X^2) - (E(X))^2$$

Seite 7 | 76

is the change in value of instrument i given the shift $c_j^{(m)}$ to the j -th risk factor. (This is referred to as the size of the gross risk position from instrument i with respect to the j -th risk factor given the shift $c_j^{(m)}$). For the risk factor “shock to slope of money market/swap rate curve in the currency (residual)” a modified specification of the size of the risk position is used because this particular risk factor shocks two pricing parameters – the short term and the long term forward rates – into opposite directions.

The sizes $size_{ij}^{(m)}$ of the gross risk positions represent the bank’s portfolio. The bank also has to determine the pricing parameters p_i , subject to instructions given in the rules. **The formulas for the determination of the capital charges and the values for the parameters $q_j^{(m)}$, $c_j^{(m)}$, $d_j^{(m)}$ and es_α would be specified in the rules.**

For all instruments that are **linear, or linearised**, in a risk factor, the shifts $c_j^{(m)}$ from the general specification in expression (4) are replaced by an infinitesimally small shift to the risk factor. This means that the sizes of the gross risk positions are determined as

$$size_{ij} = \frac{\partial MV_i((1+c_j) \cdot p_i)}{\partial c_j}, \quad (5)$$

the first partial derivative of the market value of instrument i with respect to the j -th risk factor. For linear, and linearised instruments, this size of the gross risk position applies to all potential realisations of the j -th random variable, i.e., there is no need to subdivide the range of the potential realisations of this random variable into intervals.

When the j -th risk factor is **normally distributed** and **all instruments are linear, or linearised**, in the j -th risk factor, the contribution of the j -th risk factor according to expression (2) simplifies to

$$Var\left(\sum_i \Delta_j MV_i(RF_j)\right) \approx \left(\sigma_j \cdot \sum_i size_{ij}\right)^2, \quad (6)$$

where σ_j is the standard deviation of the j -th risk factor, i.e., the standard deviation of the shock from this risk factor to the relevant pricing parameter p_i .

3. Non-technical description

3.1 Overview of the capital charge calculation

In order to determine the capital charge for a risk factor class, a bank would go through the following steps:

Step 1: The bank maps each instrument to the applicable risk factors.

For this step the bank must express the value of each instrument as a function of pricing parameters that are shocked by the regulatory risk factors.

Step 2: The bank determines the size of the net risk position for each risk factor.

Where banks generally use pricing models to value an instrument for risk controlling purposes, the bank would also have to use a pricing model to determine the size of its risk positions from this instrument with respect to the applicable risk factors. The bank uses its pricing model to determine the size of the gross risk positions for interest rate risk and credit risk, and to determine the size of the gross risk positions from non-linear instruments. These gross risk positions represent the portfolio of the bank. The sizes of the gross and net risk positions are determined separately for each risk factor.

Step 3: The bank aggregates its net risk positions across risk factors of the same risk factor class to determine a capital charge.

The calibration of the approach is reflected in step 3: for each risk factor, the rules would specify a density function. For risk factors that are treated as normally distributed, i.e. all risk factors except those related to credit spread risk, the rule would only provide a standard deviation, or risk weight. With respect to the calibration of the proposal, one of the aims would be to restrict the number of different risk weights to five per risk factor class.

Furthermore, the assumed independence of the risk factors comes to bear in step 3: the bank would determine the capital charge for each risk factor class as the square root of the sum of the variances of the changes in value caused by the individual risk factors, multiplied by a scalar.

In order to calculate the capital charge the bank would have to perform the following tasks: in order to apply the algorithm for determining the capital charge, the bank would have to express the value of each instrument as a function of pricing parameters that are shocked by the

regulatory risk factors, and determine the sizes of the gross risk positions. No further input would be required from the bank, although it would still be up to the bank to compute the size of the net risk positions from the gross risk positions according to step 2, and to compute the capital charge from the sizes of the net risk positions according to step 3. Yet, the bank would have to make these computations according to a regulatory algorithm: The Committee would specify all relevant parameters and formulas in the rules.

3.2 Calculation of the capital charge in detail

This section describes the three steps for the calculation of the capital charges.

Step 1: The bank maps each instrument to the applicable risk factors.

The rules would provide a description of the regulatory risk factors. In this way the rules would imply a set of regulatory risk factors. The rules would also explain which risk factors the bank would have to apply to any given instrument. The risk factors would be set up as (random) shocks to pricing parameters, specifically as relative changes to the pricing parameters.

There would be two groups of risk factors:

- cross-cutting (or hedgeable) risk factors; and
- non-hedgeable factors.

The hedgeable risk factors are designed to reflect hedging across instruments. Each of these would apply to all instruments that are susceptible to the respective risk factor. The non-hedgeable risk factors would capture residual risks that are not captured by the hedgeable risk factors. Non-hedgeable risk factors always solely apply to the individual instrument. However, there are also instruments, e.g., cash equities, for which all risk factors are hedgeable, i.e. without non-hedgeable risk factors.

In the case of a bond, for example, the shifts to interest rates that apply across instruments are hedgeable risk factors, as are shifts to the credit spread down to the level of the credit spread for the issuer. The change in value of a bond cannot, however, be fully “explained” on the basis of the hedgeable risk factors. The residual risks for the bond are captured by non-hedgeable risk factors for that bond.

The hedgeable risk factors would be set up in a **hierarchy**. This hierarchy could take the following form:

Table 1
Hierarchy of hedgeable risk factors

Level	FX risk	Interest rate risk	Equity risk	Credit spread risk ⁸	Commodity risk
I	shock to exchange rate of domestic currency /worldwide currency basket (e.g., special drawing rights (SDR))	shock to worldwide interest rate index (e.g., SDR interest rate)	shock to worldwide equity index	shock to worldwide credit spread index	shock to worldwide commodity price index
II	shock to exchange rate of worldwide currency basket /respective foreign currency	shock to level of money market/swap rate curve in respective currency (residual)	<i>shock to equity index by industry category⁹ (residual)</i>	<i>shock to credit spread index by industry category (residual)</i>	<i>shock to price index by commodity type (e.g., combustibles, non-combustibles) (residual)</i>
III		shock to slope of money market/swap rate curve in respective currency (residual)	shock to price of individual equity (residual)	shock to credit spread for the individual issuer (residual)	<i>shock to price index for physical type of commodity (e.g., crude oil) (residual)</i>
IV		<i>shock to money market/swap rate between vertex points in respective currency (residual)</i>			

⁸ For default risk a separate charge would apply. See section 4.1.

⁹ Probably only a very broad classification by industry would be practical. Ideally such a classification would build on a categorisation found elsewhere in the Basel III framework, e.g., bank versus non-bank.

An analogous table would apply to **implied volatility**. This means that risk factors for implied volatilities would be organised as a hierarchy as well. The number of the levels and the meaning of each of the risk factor levels would have to be established in the course of further work.

Unlike the partial risk factor approach the proposal assumes that all risk factors within a risk factor class (including the risk factors for the implied volatilities) are stochastically **independent**. This implies that the pairwise correlations between any two risk factors are all set to zero. The approach would, however, still reflect correlations between pricing parameters: Whenever a common hedgeable risk factor is applied to pricing parameters that are relevant for the valuation of different transactions, a correlation between these pricing parameters is implied. For example, for the share prices of Daimler and Volkswagen the same hedgeable risk factors of levels I and II would apply. Where the share of a corporation, e.g., Commerzbank, belonging to a different industry category ("banks") is considered, the share prices of Daimler and Commerzbank would only have the hedgeable risk factor at level I in common. This would imply a higher correlation between the share prices of Daimler and Volkswagen compared to the correlation between the share prices of Daimler and Commerzbank. Which risk factors should ultimately be included will remain to be decided at the calibration of the approach.

The number of **hedgeable risk factors** would be as follows:

- At level I there would only be one risk factor for each risk category (FX, interest rate risk, etc.);
- For FX risk, there would be one risk factor for each currency at level II;
- For interest rate risk there would be one risk factor for each currency at levels II and III;
- For equity risk there would be one risk factor for each equity at level III;
- For credit spread risk there would be one risk factor for each issuer at level III;
- For all other cells in Table 1 (which are the cells with the letters in *italics*) the number and meaning of the risk factors would be specified in the calibration.

As can be seen from the list above, the lower the level of hierarchy, the greater the number of risk factors. Distinct risk factors may, however, be calibrated to have the same standard deviation (or "risk weight"). With respect to the calibration, one of the aims will be to use as few different risk weights as possible. This includes the risk weights for the

non-hedgeable risk factors. No more than five different risk weights per risk factor class could be a desirable target figure.

The **non-hedgeable risk factors** would apply when the market value of an instrument could change due to a source of risk for which there is no hedgeable risk factor. As stated above, the market value of a bond could change due to other occurrences than shifts to money market/swap rates between the regulatory vertex points in the currency in which the bond is denominated (risk factor for interest rate risk, level IV) and shifts to the credit spread for the issuer of the bond (risk factor for credit risk, level III). Such other sources of risk could, for example, include shifts to money market rates from changes to the liquidity provided by central banks, or changes to issue-specific credit spreads, which, in the case of covered bonds, result from a change of the credit quality of the collateral.¹⁰

A different picture emerges where cash equities are concerned. The price of a cash equity has a hedgeable risk factor to itself: "price of individual equity (residual)" (equity risk, level III). This means that for a cash equity there would be no non-hedgeable risk factor. This decision ensures that an equity can serve as a hedge for an option on that equity with respect to all risk aspects of the underlying. Non-hedgeable risk factors would apply to the option itself. They would technically refer to the underlying and the implied volatility.

For each instrument to which non-hedgeable risk factors apply, these non-hedgeable risk factors would be identified as follows: To start with, the bank would identify the hedgeable risk factors that would be relevant for the instrument at the lowest level of the hierarchy. Then a non-hedgeable risk factor would be created for each of these hedgeable risk factors. Each of these non-hedgeable risk factors would create an "extra variance" in addition to the variance that the respective non-hedgeable risk factor contributes to the overall variance of the change in value of the portfolio. In the bond example, the non-hedgeable risk factors would technically provide a further shock to the credit spread of the obligor (level III of the hierarchy), and to each of the forward rates within the maturity of the bond (level IV of the hierarchy).

Although hedging would not be recognised for non-hedgeable risk factors, they would still be treated as diversifiable (just like the hedgeable risk factors). This is a consequence of the assumed stochastic independence of all risk factors.

¹⁰ Similarly, a securitisation instrument that is guaranteed by a third party could be seen as essentially owed by the guarantor, and the proceeds would just be seen as collateral. This means that such a securitisation instrument could still be included in the fuller risk factor approach without using eg the shifts to the credit spreads for obligors of instruments in the securitised portfolio as risk factors.

Identifying the non-hedgeable risk factors as sources of “extra variance” in addition to the hedgeable risk factors at the lowest level of the hierarchy is a pragmatic way of reconciling the following objectives:

- capturing any residual risks, including basis risk,
- capitalising them at plausible levels; and
- keeping the rules simple.

All these objectives are achieved. Separate risk factors for residual risks are included (i.e., basis risks, in particular, are explicitly captured). Diversification benefit is granted (i.e., the residual risks are capitalised at plausible levels – the approach avoids adding up risk-weighted risk positions irrespective of sign, i.e., the “grossing-up” of risk positions, which is a feature of the current standardised measurement method). At the same time the standard deviations for the non-hedgeable risk factors could reflect the complexity of an instrument, and the risk of hedge slippage. This is discussed in more detail under step 3.

At the same time, the specification of the risk factors for residual risks builds on the specification of other risk factors that are already included in the rules (meaning that the only additional rule needed is to stipulate that there will be a non-hedgeable risk factor for any hedgeable risk factor at the lowest level of the hierarchy that applies to the instrument, and to stipulate that hedging will not be recognised for these risk factors). This approach should also have a corresponding benefit in the computational efficiency of calculating the capital charges in practice.

Note that in particular the introduction of non-hedgeable risk factors should enable supervisors to give a proportionate response when certain risks are **not modellable** with a bank’s internal model (e.g., due to a lack of market data, cf. section 4.3 of the CP): The proposal could be used to provide a capital charge for the risks that are not adequately modelled. In particular, the proposal could be used to capitalise the risks from non-modellable risk factors at eligible trading desk. Technically, this charge would however not take the form of a stress scenario which is what the CP currently envisages.

Step 2: For each risk factor the bank determines the size of the net risk position.

For each risk factor the bank would determine the instruments from which it has a risk position for this risk factor. The size of the risk position from a particular instrument is a **gross risk position** for this risk factor. A gross risk position can have a positive or negative sign.

Seite 14 | 76

This section is confined to an intuitive description of the determination of the size of the gross risk positions. For details the reader is referred to the formal description in Annex 1.

For an instrument that is **linear** in a risk factor the bank would determine the size of the gross risk position with respect to the j -th risk factor as follows:

– For a “strictly” linear instrument (e.g., an equity) the size of the gross risk position is always the market value, i.e., the number of shares multiplied by the (spot) share price. When the equity is denominated in a foreign currency, the size of the gross risk position is the corresponding amount in the bank’s reporting currency. Similarly, the size of a gross commodity risk position is the quantity (e.g., in tons) multiplied by the (spot) price of the commodity (i.e., again the corresponding amount). For foreign exchange risk the gross risk position is the market value of the instrument converted (at the current exchange rate) to the reporting currency of the bank.

Interest-rate related instruments without option features, tranching, etc., are treated as linear by approximation. An infinitesimally small shift of the risk factor is used to determine the size of the gross risk position with respect to the relevant risk factor. The risk factors at levels I and II shift the curve of all forward rates simultaneously. At level III, the forward rates beyond 4 years are shifted in the opposite direction to the forward rate for the interval 0 to 1 years. At level IV, and for the non-hedgeable risk factors, the forward rates are shifted separately for the intervals 0 to 1 years, 1 to 4 years, and beyond 4 years.

For simplicity, options will be treated at this point as approximately linear in the risk factors for implied volatility.

For each risk factor, the bank would determine the size of the **net risk position** as the sum of the sizes of the gross risk positions, allowing for the signs. When the bank has risk positions of different signs for a risk factor, the summation of the risk positions represents a **hedging** benefit.

Diversification across risk factors is only recognised at step 3 when the contributions of the risk factors to the overall portfolio variance are added up. The extent of the diversification effect depends, however, on the size of the net risk positions from step 2: Where a bank only has risk positions of the same sign for a risk factor, the sizes of the gross risk positions will accumulate to a net risk position of a large size. This signifies a risk concentration with respect to this risk factor which is rightly captured by a diversification benefit that is reduced relative to a portfo-

lio for which the sizes of the net risk positions are more evenly spread across risk factors.

For an instrument that is **non-linear** in a risk factor (e.g., a put option on Daimler shares) the variance of the change of the portfolio value for this risk factor would be determined by an approximation technique called "local linearisation". Local linearisation would apply to all risk factors in which the instrument is non-linear. In the example of the Daimler put this would be all three risk factors from the hierarchy of hedgeable risk factors that shift the Daimler price, as well as the non-hedgeable risk factor that is included to capture residual risk from the derivative.

The bank would have to determine the size of the net risk positions from each non-linear instrument with respect to six shifts for each relevant risk factor: -2.5, -1.5, -0.5, +0.5, +1.5 and +2.5 multiplied by the standard deviation of the respective risk factor. For each risk factor, the instrument (the put option on Daimler shares) is then revalued for each of the six shifts to the pricing parameter (the Daimler price). The change in value divided by the shift is the size of the gross risk position from the instrument with respect to the relevant risk factor, given this shift. The bank would use its own pricing model to determine the size of the gross risk position.¹¹ In principle, it may be desirable to determine that size using exact revaluation, in particular when non-linear instruments are concerned. After all, Taylor-approximation may not perform well, even for small shifts (think of, e.g., an at-the-money option with a few days to maturity). However, there is a substantial implementation cost with exact revaluation. At this point only banks that use the scenario approach according to paras 718(Lxiii) to 718(Lxvii) of the Accord currently use exact revaluation as part of the standardised measurement method for market risk. The other banks that use the standardised measurement method will use the delta-plus method according to paras 718(Lxi) to 718(Lxii) for options (unless they can use the simplified approach according to para 718(Lviii)). The delta-plus method addresses curvature by using delta and gamma, i.e. through Taylor approximation. Not least to minimise the changes this proposal implies for banks' reporting software, banks could be given a choice how they determine the size of the gross risk positions from non-linear instruments with respect to risk factors that shock pricing parameters

¹¹ This implies that the fuller risk factor approach can only be used when a bank has a pricing model to determine the value change of an instrument as a function of the underlying risk factors. Banks are expected to be able to run such scenario analyses. Where a bank lacks an adequate pricing model, a conservative flat capital charge would apply. Examples of instruments to which such a conservative fallback treatment would apply include residential mortgage securitisations, or structured products which the bank buys on behalf of clients but does not manage itself. (Background: In May 2009, the Committee issued its *Principles for sound stress testing practices and supervision* that include the following standard: "The infrastructure should enable the bank on a timely basis to aggregate its exposures to a given risk factor, product or counterparty, and modify methodologies to apply new scenarios as needed" (Principle 5 for banks on page 11).)

Seite 16 | 76

for the underlying: They could use either exact revaluation or Taylor approximation for the relevant instruments.

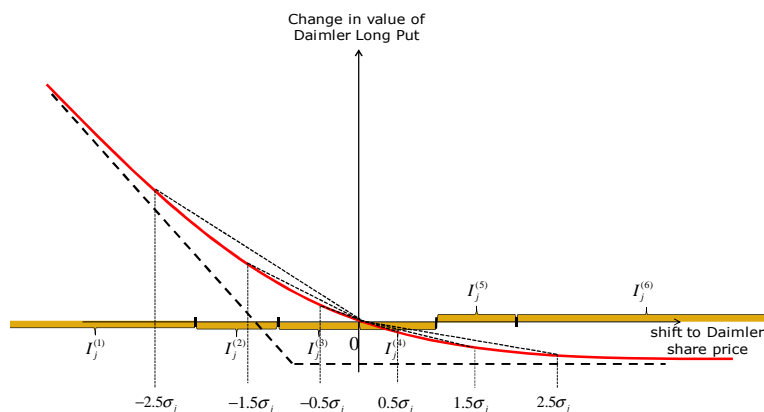

Figure 3: Local linearisation

For each shift the sizes of the gross risk positions are added up to determine the size of the net risk position with respect to the relevant risk factor, given this shift. The size of the net risk position would also include the gross risk position from instruments that are *linear* in this risk factor. (The size of the gross risk positions from linear instruments would of course be the same for each of the shifts, i.e., the size of the gross risk position from an instrument that is linear in a risk factor would have to be determined only once, and without regard to the shifts that are applied to instruments that are non-linear in this risk factor.)

As for non-hedgeable risk factors, hedging is not recognised; the size of the net risk position will always equal the size of the gross risk position for these risk factors.

Note that the sizes of the net risk positions could also be used for **regulatory reporting**. For risk factors for which there is an instrument that is non-linear in this risk factor the size of the net risk position would by construction relate to the size of the shift. For risk factors in which all instruments are linear or linearised the size of the net risk position could be weighted by the standard deviation of the risk factor. In this way the risks associated with the respective risk factors would be reported in a “common currency”. This representation of banks’ market risks in a “common currency” could also facilitate macro-prudential analysis.

Step 3: The bank will aggregate its net risk positions across risk factors to determine a capital requirement per risk category.

For each risk factor class, the bank would determine the ES from the size of the net risk positions for all risk factors belonging to the respective risk factor class. For this purpose, it would:

- (a) determine the contribution of the j -th risk factor to the portfolio variance, i.e., the variance of the change in value of the portfolio from this risk factor;
- (b) determine the portfolio variance by summing up the variances from step (a) across all risk factors;
- (c) determine the portfolio standard deviation by taking the square root of the portfolio variance from step (b); and
- (d) determine the capital charge for the risk factor class by multiplying the portfolio standard deviation from step (c) by a scalar.

The bank would use formula (2) in section 2 to determine the contribution of the j -th risk factor according to step (a) when the portfolio includes an instrument that is linear in the risk factor, and generally when the risk factor relates to credit spread risk. The bank would use formula (6) in section 2 when the risk factor does not represent credit risk and all instruments are linear or linearised in the risk factor. The mathematical description in Annex 1 provides a derivation of these formulas. It also lists the parameters that would be used to determine the contribution of a risk factor (other than for credit spread risk) when the portfolio includes at least one instrument that is non-linear in that risk factor.

At this point we only provide an intuition on how the contribution of the j -th risk factor is determined when at least one risk factor is non-linear in this risk factor: The range of potential shifts to that risk factor is decomposed into six intervals. For each interval a representative shift $c_j^{(m)}$ is determined. For each of these shifts the bank determines the size of the net risk position separately. This means that hedging with respect to a risk factor is recognised in a scenario-consistent and risk-sensitive way. This is important to make the proposal a **credible fallback** when a bank's internal model is deficient. **Such a credible fallback is most needed for desks that trade non-vanilla instruments.** Consider two examples:

Example 1: Equity options

Consider a combination of a short call and a long put on the same equity that also have the same strike prices. Apart from basis risk, this can synthetically offset a long cash position in the equity. The proposal would recognise the hedge with respect to all three hedgeable risk factors that shock the equity price (world-wide stock index, industry stock index, equity residual). Likewise, the hedge for the implied volatility would be recognised with respect to all hedgeable risk factors that shock the implied volatility of the two options (analogous levelling for implied volatility).¹² Basis risk is captured by the non-hedgeable risk factors that would apply to both options.

Example 2: Interest rate options

Consider a bond with a cap on interest rates. The interest rate risk, apart from the cap, is hedged by an interest rate swap. The fuller risk factor approach would recognise the hedge – to the extent it exists despite the cap – with respect to all applicable hedgeable risk factors. The open risk position with respect to the implied volatility would be recognised through gross risk positions with respect to the risk factors that shock the implied volatility. Non-hedgeable risk factors would apply to both instruments.¹³

This size of the net risk position applies to all potential shifts in the interval. This “local linearisation” reflects the curvature of the non-linear instrument with respect to the risk factor. Using the probabilities $q_j^{(m)}$ of the six intervals, the variance contributed by the risk factor to the overall variance of the change in value of the portfolio is then determined in a computationally convenient manner, using formula (2) in section 2. The above steps (a) to (d) follow from the simplifying assumptions and

¹² The partial risk factor approach would assign options with the same underlying in part to different buckets (cf. p. 80 of the CP). Puts and calls would always be assigned to different buckets. Within the buckets the correlation parameters are estimated as the median of the pairwise correlations between the delta-adjusted returns between the options of the respective group. This approach could also be applied to estimate correlations across “option buckets”. Across buckets most pairs of options will be of different underlyings. This means that the median could be a correlation between options of different underlyings. As one would expect the correlation between options of the same underlying to be larger than that between options of different underlyings this could imply that across buckets the correlation between options of the same underlying are systematically understated. For predominantly hedged portfolios the risk could then be systematically overstated, for predominantly one-directional portfolios predominantly overstated.

¹³ The partial risk factor approach would apply the cash flow vertices method to the swap, but not the bond. Instead the bond would be assigned to a separate bucket that captures its entire risk. Any offsets between the bond and the swap would be recognised only within the limits of the broad-brush aggregation across buckets.

Seite 19 | 76

approximations on which the proposal is based. These are set forth in Annex 1 as well.

Given its assumptions and approximations the approach will be better equipped to capture the risks from standard products compared to other products. For example, the risk factors are set up as one-off shifts to the pricing parameter to which they are applied. No particular time path is specified. This means that the following risks are not captured in a detailed manner:

1. the risks that are particular to path-dependent instruments (e.g., Asian options, barrier options); and
2. hedge slippage risk – i.e. the risk that an instrument serving as a hedge matures before the hedged instrument and may not immediately be replaced by a new instrument at roll.

Both issues can be addressed by imposing higher standard deviations on the non-hedgeable risk factors. The first risk would be addressed by applying higher standard deviations for all non-hedgeable risk factors that shock the pricing parameters of more exotic products. With respect to the second risk, higher standard deviations would apply when an instrument matures before sum threshold value that could be set e.g. at the level of a risk factor class. For example, a forward purchase of an equity with a remaining maturity of just one day would attract a higher standard deviation for the non-hedgeable risk factor for the residual risk from the equity than a forward purchase of the same equity with a maturity that exceeds the threshold. By using the standard deviations of the non-hedgeable risk factors as a tool, the additional risks from more complex products and hedge slippage are treated on a proportionate basis under the approach.

Calibration

There are two levers for the calibration of the proposal: The first (perhaps not quite too obvious) is the specification of the risk factors (this determines in particular the degree of hedging recognition), and the second the calibration of the standard deviations of the risk factors and the scalar ϵ_{s_α} . The following remarks outline what needs to be done for the calibration.

On the specification of the risk factors we have already noted above: For all cells in Table 1 with the letters in *italics* the number and meaning of the risk factors would be specified in the calibration.

The standard deviation of a risk factor actually has the same function as a **risk weight** in the current standardised measurement method, in that it weighs the size of the net risk position. The scalar according to step

Seite 20 | 76

(d) is to capture tail properties of the joint distribution of the risk factors. It could be used for the calibration of the overall level of capital charges under the approach.

The risk factors below level I of the hierarchy are set up as residuals. This means that the risk factors at each level of the hierarchy below level I are designed to capture only those risks not already captured by a risk factor higher up in the hierarchy. In this way, any double counting of risk should be avoided.

This “orthogonalisation” of the risk factors, i.e., their specification as independent random variables, should provide the Committee with a **parsimonious and transparent set of parameters with which it could control, in particular, the extent of recognition for hedging and diversification** under the revised standardised approach. The general rule would be:

- The higher the standard deviations of the risk factors at the lower level of the hierarchy (where the instruments are mapped to many distinct risk factors) relative to the standard deviations for the risk factors at the higher level of the hierarchy (where the instruments are mapped to just a few risk factors), the lower the hedging benefit.¹⁴
- The more distinct risk factors are created at any level below level I (and above the instrument level), the lower the hedging benefits (as instruments will be mapped to more distinct risk factors).¹⁵

A stress calibration would therefore be achieved by increasing the standard deviations of the risk factors at the lower level of the hierarchy relative to the standard deviations for the risk factors at the higher level of the hierarchy, relative to what is observed in “normal times”. This applies at least to a bank that takes long and short risk position, being typical for a bank that is exposed to substantial market risk. This calibration would be made with the aim of recognising hedges only to the extent that, based on experience, they are likely to be effective in times of crisis.

Each vector of standard deviations for the set of risk factors would imply a particular pattern of standard deviations for the pricing parameters and for pairwise correlations between them. The Committee could compare the implied patterns to the patterns that had been observed over a certain period. In this way it could check the plausibility of a parametric

¹⁴ There is a counteracting effect as the diversification benefit would increase. The relative size of these effects will depend on the portfolio composition. For a bank that takes long and short risk positions, the effect on the hedging would probably dominate.

¹⁵ Again there is a counteracting effect as the diversification benefits would increase.

sation. Such comparisons could be made, in particular, for different episodes of crises.

In order to facilitate the estimation and the plausibility checks the standard deviations may, in a first step, be calibrated for identical forecasting horizons. In a second step, the calibrations would be adjusted for liquidity horizon. This adjustment would refer to the cells of Table 1 (i.e., combination of risk factor class, e.g., equity, and level in the hierarchy, e.g., level III). In some cases, the liquidity horizon may depend on further characteristics, e.g., the residual risk from the credit spread by industry may differ depending on whether an issuer is a sovereign or a corporation.

The calibration will however not be a solely data-driven exercise. In some cases, empirical volatilities and correlations may be tied to the bank-specific notion of risk. Such data may not reflect all the risk that the Committee may wish to capitalise. For example, the Committee may use its judgment to allow for risks that have not materialised due to public interventions (e.g., in the case of managed exchange rates or interest rates).

In some cases (e.g., currently for certain interest rates and credit spreads) the level of the pricing parameter that is shifted by a certain risk factor may be so low that insufficient capital charges would result. It could even be negative. Whilst the pricing parameter would remain unchanged for the valuation of the instrument, it could be floored at a certain absolute level when it comes to determining the size of the gross risk position. The standard deviation for a risk factor that applies to the pricing parameter would then be multiplied by the pricing parameter at the level of the floor. Whether such a floor is desirable is an empirical matter. At the limit a flat pricing parameter could be applied for a given risk factor. This would be equivalent to expressing the standard deviations of the shocks to pricing parameters in percentage point changes to the interest rates, not as relative changes. Again, the assessment of whether this is desirable for the rather diverse levels of interest rates world-wide would have to be made based on empirical analysis.

4. Credit Risk

The design of the capital charges for credit risk in the trading book differs from capital charges for the other risk factor classes in the following respects:

- a skewed probability distribution is used to derive the shocks to credit spreads.
- for pure default risk, hedging is recognised only at the micro-level, i.e., name by name.
- model risk is particularly recognised for securitisation instruments.
- The calibration is linked to the capital charges for credit risk in the banking book, in order to address the issue of capital arbitrage.

For derivatives, the Basel III capital charge for CVA risk (CVA = credit value adjustment) would continue to apply.

We first outline the general framework. In this context we also discuss the capitalisation of default risk. We then outline the capitalisation of credit spread risk.

4.1 The framework

Figure 4 provides an overview on the envisaged capitalisation of credit risk in the trading book:

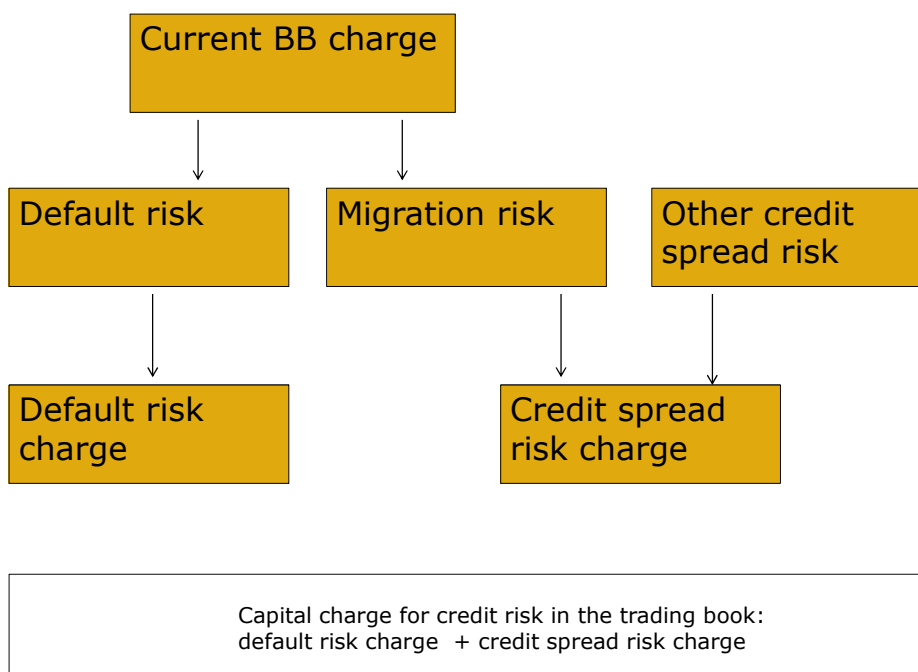

Figure 4: Capital charge for credit risk – overview

The current banking book (BB) capital charge capitalises two kinds of risk: pure default risk and migration risk. Both components capitalise potential losses from a shock to a single systematic risk factor. For the internal ratings-based approach migration risk is explicitly captured by the maturity adjustment in the risk weight formula. For the standardised approach both risks are capitalised implicitly because its risk weights are calibrated in relation to those of the internal ratings-based approach.

For counterparty credit risk Basel III also introduces a capital charge for CVA risk. As counterparty credit risk is already subject to the BB risk weights for credit risk, this charge capitalises the risk of credit spread

changes for counterparties that are not linked to rating migration risk (e.g., credit spread changes from a general increase in investors' risk aversion). The standardised CVA risk capital charge capitalises credit risk again with respect to a single systematic risk factor, but also with respect to name-specific risk factors. The contributions to portfolio variance are added up across risk factors. In other words, it uses a hierarchy of risk factors and further assumptions similar to those for our proposal.

For the trading book, including the standardised approach, it is natural to capitalise all sources of credit spread risk. Therefore, our proposal includes a "credit spread risk charge".

The Committee has identified different capital treatments for the same risks on either side of the boundary between trading book and banking book as an issue of concern.¹⁶ This is an issue in particular for credit risk, as credit-risky instruments will continue to be included in either book under both boundary proposals. Accordingly, the treatment of credit risk under the proposal is designed to ensure that the capital charges for credit risk for instruments in the trading book follow the same a conceptual basis and are as consistent as possible with those in the banking book.

For default risk this means that the proposal would include a capital charge for pure default risk. As in the banking book this would apply only to instruments that lead to "long" credit risk positions. The level of the capital charges would be calibrated to the charges for pure default risk that are implicit in the banking book capital charges for credit risk.¹⁷ The rules would specify how the capital charge for the individual "long" credit risk position would be determined. It could be made a function of the credit spreads that are implied by the market price of the instrument. Alternatively, simple flat charges could be used as in the standardised approach for credit risk in the banking book.

Hedging for default risk would be recognised according to the banking book rules. This means that risk mitigation for default risk would only be recognised when the bank has credit protection for the same name. This approach is taken because defaults are relatively rare and idiosyncratic events. To recognise hedging across names would amount to an implicit assumption that, when obligor A defaults, some other obligor for whom the bank has shortened credit risk would default as well. Note that the universe of issuers whose debt is traded is by far smaller than the set of all entities that issue debt at all, i.e., recognition of "macro-hedging" for credit risk would be particularly problematic in the context of the trading

¹⁶ Cf. the section on interest rate risk in the banking book on p. 6 of the CP.

¹⁷ For securitisation instruments, the pure default risk component of the capital charge may be more difficult to identify than that for straight bonds.

Seite 25 | 76

book, at least in a standardised approach as a simple regulatory algorithm.

For credit spread risk, capital charges would apply to both long and short risk positions with some recognition for macro-hedging. This is reflected by the hierarchy of risk factors for credit spread risk in Table 1 in section 3.2. Details are provided in section 4.2. Shocks to the bank's own credit risk would not be considered for the credit spread risk charge because gains or losses from changes on credit spreads for a bank's own debt do not affect regulatory capital due to prudential filters. An economic reason for this approach is that banks generally cannot realise gains from an increase of its own credit spread as liquidity is a constraint.

Note that the capitalisation of all "credit spread risk" under the proposal may make it advisable to capitalise credit spread risk beyond migration risk in the banking book as well. As stated above, this part of credit spread risk is currently only capitalised for the counterparty credit risk from derivatives.

4.2 Capitalisation of credit spread risk

This outline of the treatment for credit spread risk focuses on the differences to the treatment for the other risk factor classes. These differences are discussed for each of the three steps in turn.

Step 1: mapping to the risk factors

As for the other risk factor classes, the bank must use pricing parameters p_i such that $MV_i((1+rf_j) \cdot p_i)$, the value of instrument i given a (deterministic) shift $rf_j \neq 0$ to the j -th risk factor, is a well-defined expression.

For the time being the risk factors are specified as a shock to the $P_{cs_obl,k}$ the defaultable instantaneous forward rate for the obligor for the k -th time interval with a loss given default of 100%.¹⁸ These purely issuer-related credit spreads are used to simplify the comparison of the calibration of the risk factor for credit spread risk at level I ("shock to worldwide credit spread index") to that of the charge for migration risk

¹⁸ Cf. Annex 2, example 2: zero-coupon bond.

Seite 26 | 76

under the internal ratings-based approach for credit risk. It is, however, an open practical and empirical question as to whether it is better to define the risk factors as shocks to a credit spread that includes the (market-implied) loss given default as well.

The risk factor “shock to worldwide credit spread index” has an economic interpretation as a shock to the single systematic risk factor underlying the risk weighting formula for the internal ratings-based approach. With respect to this risk factor, macro-hedging for credit spread risk would be recognised across all credit risky instruments in the trading book (except for the counterparty credit risk, including CVA risk, which is subject to separate capital charges).

Securitisation instruments could in principle be capitalised using the proposal. However, in this case the bank would have to have a pricing model that would allow it to determine the change in value of the instrument given changes to the credit spreads for the obligors of the securitised portfolio and the implied correlation. Even where such a pricing model is in place, the valuation of securitisation instruments is still fraught with particularly high model risk. In particular, this raises the question as to whether hedging should at all be recognised with respect to risk factors that shock the implied correlation. Should hedging recognition be seen as undesirable, the implied correlations would be shocked only by non-hedgeable risk factors.

Step 2: gross and net risk positions

The general definition for the size of the gross risk position according to expression (4) of section 2 applies to the risk factors for credit spread risk as well.

The density function of the shocks to the risk factors may be materially skewed. This applies in particular to obligors with a low probability of default. This is illustrated by figures 5 and 6.

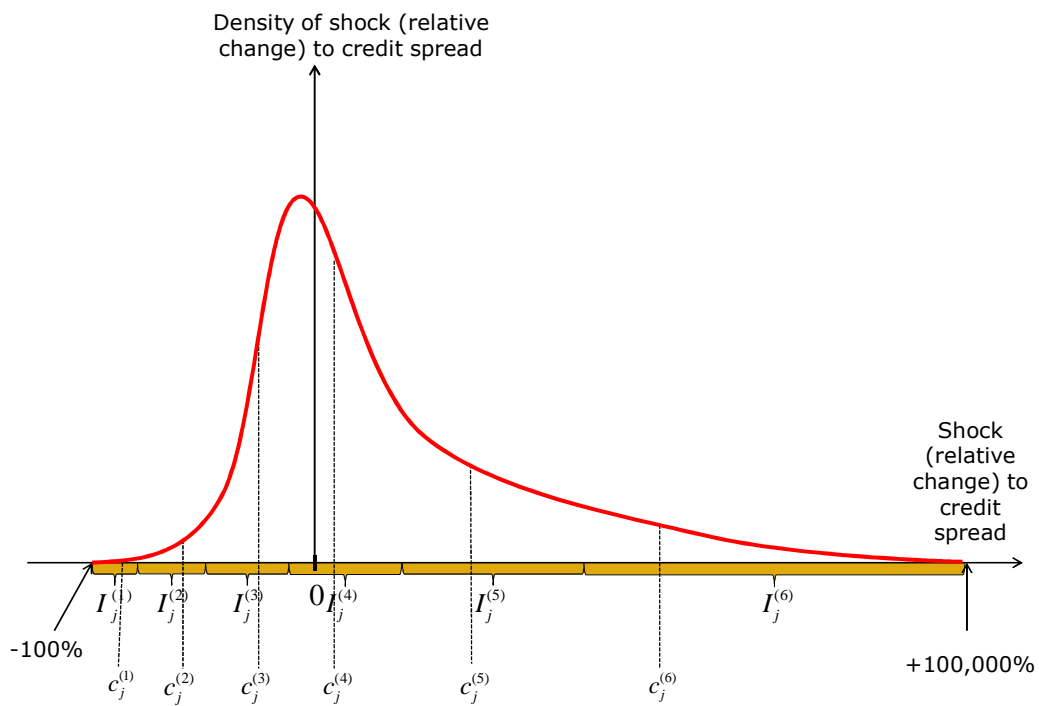

Figure 5: Stylised density of a risk factor that shocks an issuer credit spread of **10 BP**

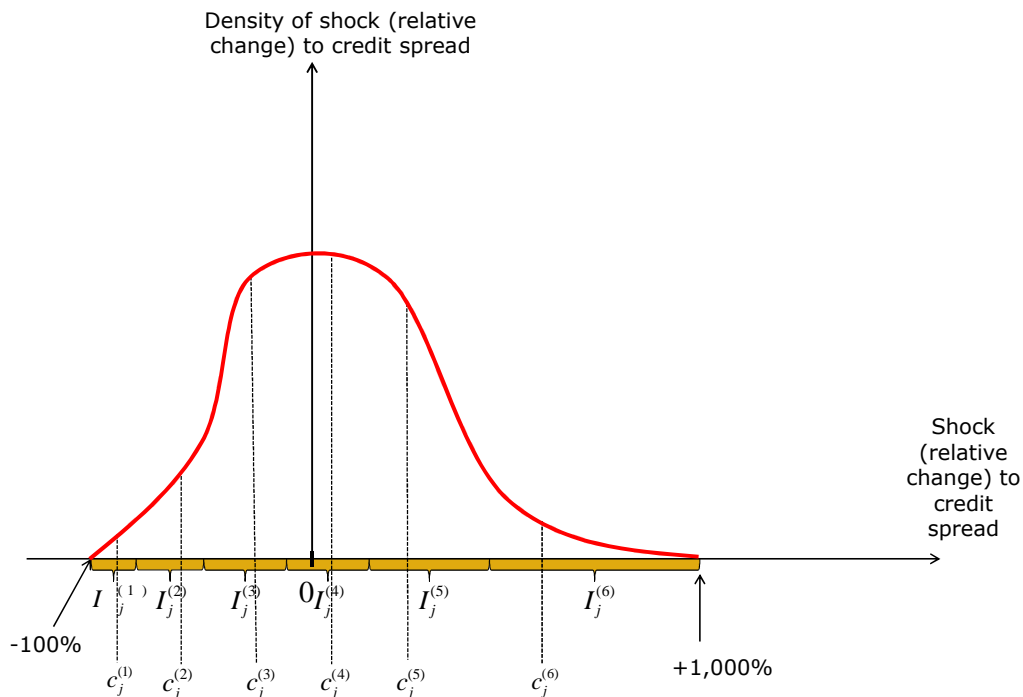

Figure 6: Stylised density of a risk factor that shocks an issuer credit spread of **1000 BP**

The stylised density functions are drawn such that credit spreads below 0 and above 1 (100%) are ruled out. They are relevant to risk factors at any level of the hierarchy.

The skewness of the density functions can be addressed by adapting the local linearisation technique to discretise the skewed density function. Ideally, a simple continuous function could be found that relates the relevant parameters to the issuer credit spreads and some dispersion parameter. The relevant parameters are those needed to determine the variance that the j -th risk factor contributes to the overall variance of the change in value of the portfolio according to expression (2) in section 2, i.e., the probabilities q_m , and the equivalents to the conditional probabilities $\sigma_j \cdot a_m$ (shown as $c_j^{(m)}$ in figures 5 and 6), and $\sigma_j^2 \cdot b_m$. Alternatively, certain shapes of the density function for a small number of intervals for the issuer credit spreads could be imposed. Note that the discretised density functions would be applied irrespectively of whether instruments are linear or non-linear in the risk factor.

Seite 29 | 76

Note that the approach for credit spread risk could be extended to other kinds of risk for which skewed density functions are an issue. An example would be the underlying of catastrophe bonds.

Step 3: capital charge

— The capital charge would be determined in the same manner as for the other risk factor classes. This implies, for example, that it would apply irrespective of whether a bank is predominantly “long” or “short” credit spread risk.

The calibration would pay due regard to the aim of limiting opportunities for capital arbitrage to the banking book. Given that hedging would be recognised to an extent for credit spread risk, the capital charge for credit spread risk for a “long-only” portfolio may be calibrated to an amount above the one implied by the risk weights in the banking book. Whether this would be before or after allowing for potentially shorter liquidity horizons than in the banking book would be for the Committee to decide.

Annex 1: Formal derivation

The bank would determine the capital charge for market risk from the capital charges for the five risk factor classes (equity risk, interest rate risk, FX risk, commodity risk and credit risk). These individual capital charges will be aggregated using a variant of the risk aggregation formula (1) in section 4.5.6 of the CP.

This section provides a formal derivation of the formulas provided in section 2, and background on the underlying mathematical assumptions. The particularities of the capital charge for credit risk are outlined in section 4 of the proposal.

The description starts with the formula for the capital charge for a given risk factor class. It then introduces the underlying mathematical assumptions. The remaining sub-sections present the steps 1 to 3 for the calculation of the capital charge in formal notation. Throughout this annex the same notation is used as for the general formulaic description in section 2.

1 Overall capital charge

As stated in formula (1) in section 2, for each of the risk factor classes equity risk, interest rate risk, FX risk and commodity risk, and for credit spread risk the bank would determine the capital charge by approximating the expected shortfall (ES) as follows:

$$ES_{\alpha} \approx es_{\alpha} \cdot \sqrt{\sum_j \text{Var} \left(\sum_i \Delta_j MV_i (RF_j) \right)}, \quad (1)$$

Underlying assumptions

This section presents the simplifying mathematical assumptions underlying expression (1)¹⁹ and describes the effect of each assumption. The first two assumptions are essential in order to meet the Committee's objective for the revised standardised approach to be simple and

¹⁹ The formulas in this annex are numbered starting with (1).

transparent in the context of the proposal. Therefore, a detailed rationale is provided for these two assumptions.

2.1 The assumptions in context

The assumptions underlying expression (1) are the following:

1. **separability:** the change in value of any instrument i as a function of the vector $vec(RF_j)$ of all risk factors is approximately equal to the sum of the separate changes in value attributed to the individual risk factors RF_j ;
2. **independence:** all risk factors within the same risk factor class are statistically independent;
3. **normal distribution:** except for credit spread risk, all risk factors of a given risk factor class have a joint normal distribution, subject to an adjustment for kurtosis, with an expected value of zero; and
4. **expected shortfall proportional to portfolio standard deviation:** the expected shortfall is a multiple of the standard deviation of the change in value of the overall portfolio.

The first two assumptions in combination imply that the portfolio variance, i.e. the variance of the change in value of the portfolio

$Var\left(\sum_i \Delta MV_i(vec(RF_j))\right)$, can be approximated by the sum of the variances of the changes in value that are attributed to the individual risk factors $\sum_j Var\left(\sum_i \Delta_j MV_i(RF_j)\right)$; or formally:

$$\begin{aligned}
 & \text{Var}\left(\sum_i \Delta MV_i(\text{vec}(RF_j))\right) \\
 & \approx \text{Var}\left(\sum_i \sum_j \Delta_j MV_i(RF_j)\right) \quad (1^{\text{st}} \text{ assumption}) \\
 & \approx \sum_j \text{Var}\left(\sum_i \Delta_j MV_i(RF_j)\right) \quad (2^{\text{nd}} \text{ assumption})
 \end{aligned} \tag{2}$$

This means that the contribution to the portfolio variance can be determined separately for each risk factor. These contributions are merely added up to arrive at the portfolio variance. The third assumption whereby the risk factors of a given risk factor class are assumed to have a joint normal distribution with an expected value of zero is made for ease of computation. At this point only for risk factors associated with credit spread risk, it is proposed to use a skewed distribution.

Unfortunately, the change in value of the portfolio will be normally distributed as well only when all instruments are linear in all risk factors.

In that case, the portfolio variance $\sum_j \text{Var}\left(\sum_i \Delta_j MV_i(RF_j)\right)$ will be the variance of a normally distributed (univariate) random variable. When at least one instrument is non-linear in a risk factor j , the change in value of the instrument as a function of this risk factor, $\Delta_j MV_i(RF_j)$, will not be normally distributed. For example, when we treat the change in value of a call option as a continuous function of RF_j , this function will transform the normal distribution of RF_j into some skewed distribution.

To address this issue, we propose the "local linearisation" approximation technique at the level of the individual risk factors. Details in this connection are set forth in section 3.2 of this annex.

For each risk factor its contribution to the portfolio variance is characterised by the variance of the change in value of the portfolio that is attributed to this risk factors. This variance reflects the shape of the distribution, in particular by using local linearisation for non-linear instruments. This means that for the aggregation across risk factors, i.e., for $\sum_j \sum_i \Delta_j MV_i(RF_j)$, the change in value at the overall portfolio level, the

different shapes of the distributions $\sum_i \Delta_j MV_i(RF_j)$ for the change in value of the portfolio attributed to the j-th risk factor are only taken into account insofar as it affects the variance of the j-th risk factor's contribution. This is what assumption 4 states: The expected shortfall is assumed to be a multiple of the standard deviation for the change in value of the overall portfolio. This permits the use of the portfolio variance $\sum_j \text{Var}\left(\sum_i \Delta_j MV_i(RF_j)\right)$ as a basis for determining the capital charge for the risk factor class, even when the $\sum_i \Delta_j MV_i(RF_j)$ are not normally distributed. The scalar es_α would provide an adjustment to reflect that the kurtosis of the distribution for the overall change in value of the portfolio will exceed the kurtosis of the normal distribution. If the tail properties differ across the risk factors, this could be addressed by approximation using higher standard deviations for the risk factor shocks with particularly "fat" tails.

Implicit to assumption four is also that for any instrument we assume an expected change in value of zero. This means that for interest-related instrument we disregard the pull to par effect. For options theta effects are disregarded. This approach is taken again for simplicity. The size of the error that it implies depends on the liquidity horizons that the Committee will set. If ultimately desired, a drift other than zero could be added to the framework.

The four assumptions taken together lead to the following approximation:

$$\begin{aligned}
 ES_\alpha &= ES_\alpha \left(\sum_i \Delta MV_i(\text{vec}(RF_j)) \right) \\
 &\approx es_\alpha \cdot \sqrt{\sum_j \text{Var}\left(\sum_i \Delta_j MV_i(RF_j)\right)}.^{20}
 \end{aligned}
 \tag{3}$$

²⁰ In line with the notation used in the CP ES_α is written in capital letters, although it does not refer to a random variable: Before the equation sign it denotes a real number, after the equation sign a function.

2.2 On assumption no. 1: separability

Formally the first assumption can be written as

$$\Delta MV_i(\text{vec}(RF_j)) \approx \sum_j \Delta_j MV_i(RF_j) \quad (4)$$

In words: the change in value of any instrument i from a joint shock to all risk factors, i.e., $\Delta MV_i(\text{vec}(RF_j))$, is assumed to equal the sum of the changes in value where each risk factor is shocked individually, and all other risk factors remain unchanged, i.e., $\sum_j \Delta_j MV_i(RF_j)$. This as-

sumption can be paraphrased as an assumption that the cross gamma between any pair of risk factors is assumed to be zero.

Even for internal models it is common to assume that certain cross gammas are zero. For bonds that are denominated in a foreign currency, for example, the cross gamma with respect to the combined effect from a change in the exchange rate and a change in the interest rates is usually ignored.²¹ Note that where cross gammas are ignored, even where this is common for models, this may result in neglecting wrong-way risk. For example, the change in value of the underlying of a derivative may drive its value up, precisely when a deterioration of the creditworthiness of the counterparty drives the value down.

In the proposal, the cross gammas for risk factors that shock the *same* pricing parameter would also be set to zero. Consider the example of the put option on Daimler shares in annex 2 (Example 1a, step 2): Assume a scenario where all four risk factors that shock the Daimler share price take a very low value, i.e., a value from the interval no. 1 for the respective risk factor. Based on the Daimler share price, the secant slope for the combined move is probably close to one for this combined scenario, whilst in the example a secant slope close of 0.9 applies in the first interval for all four risk factors. In other words: If the change in value for the combined move were reflected more accurately (i.e. cross gamma effects recognised) a secant slope of close to 1 would apply. The separability assumption disregards the cross gamma effect, and uses the secant slopes of 0.9 for the individual moves also for the joint move.

For purposes of assessing the separability assumption, two aspects have to be weighed: i). the "error" introduced by the assumption relative to an internal model, and ii) the gain in simplicity and transparency.

²¹ This approach is also taken by the partial risk factor approach for the cross-cutting risk factors (cf. section 1 of Annex 6 of the Consultative Document).

With respect to the “error” caused by the separability assumption with respect to an instrument that is non-linear in a risk factor, it should be noted that for “inner” combined scenarios (i.e., we do not combine only the intervals no. 1 or just the intervals no. 6 for all risk factors), the secant slopes combine to some “average” secant slope. It is an empirical question how such “average” secant slopes would differ from the secant slopes that would result from firstly aggregating the distributions of the risk factors and secondly determining the secant slopes for the combined change to the value of the underlying.

When considering the size of “errors” caused by the separability assumption, one should also bear in mind that the proposal aims to keep the number of different standard deviations (or risk weights) for the risk factors of a given risk factor class to a maximum of five. This means that any accuracy gained by renouncing on the separability assumption could be spurious, given the parsimony of the envisaged calibration.

At the same time, the separability assumption leads to a drastic simplification of the proposal by comparison with the alternative of determining the secant slopes with respect to combined shifts for different risk factors, or in other words of using scenario matrices. For the put option on Daimler shares a scenario matrix only for the four risk factors that shock the Daimler prices would have six to the power of four (6^4) cells (4 risk factors of 6 shifts each). The number of cells in the matrix would be even higher for more complex products. By way of an example, consider an instrument that puts a cap on the difference between the yields between a 6-year US government bond, and a 6-year Bund: Alone for the underlying this would involve risk factors that shock six pricing parameters (shocks with respect to three EUR forward rates and to three USD forward rates).

Furthermore, the use of scenario matrices would require a rule on the allocation of linear instruments to the respective scenario matrices. And more importantly, the different scenario matrices would share at least some risk factors from the higher level of the hierarchy. This means: Although for each scenario matrix a variance could be still determined, these variances would not be additive across scenario matrices (whilst they *are* additive across risk factors). In response to this calamity, either the variances would have to be aggregated ad-hoc, i.e., without a clear conceptual basis, or a complex aggregation method, such as Monte Carlo simulation, would have to be used. Neither option is attractive.

Instead, the non-hedgeable risk factors provide a pragmatic “middle ground” solution: For instruments for which the separability assumption could lead to large “errors”, high standard deviations (or risk weights) could be applied to the non-hedgeable risk factors. In this way, hedging would still be recognised with respect to the hedgeable risk factors. At

Seite 36 | 76

the same time, the instrument would contribute a particularly high non-hedgeable variance to the overall portfolio variance.

2.3 On assumption no. 2: independence

As stated before, the independence assumption, together with the separability assumption, allows the portfolio variance to be represented as the sum of the risk factor contributions, i.e. of the variances attributed to the individual risk factors, $Var\left(\sum_i \Delta_i MV_i(RF_i)\right)$. This again greatly enhances the computational simplicity of the proposal.

The independence assumption should also facilitate a simple and transparent calibration: For each risk factor, a single parameter needs to be calibrated: its standard deviation. As the dependence between pricing parameters is built into the hierarchy of risk factors, no correlations between risk factors need to be calibrated.

In particular, this concentration of the calibration effort just on standard deviations should make it easier to combine experience from a number of episodes and exercise economic judgment in a structured way.

We use the relative movement of JPY and USD zero coupon yields (spot rates) of a maturity of five years as an illustration.

Monthly data from 2008 show that these interest rates moved by and large in the same direction in that year:

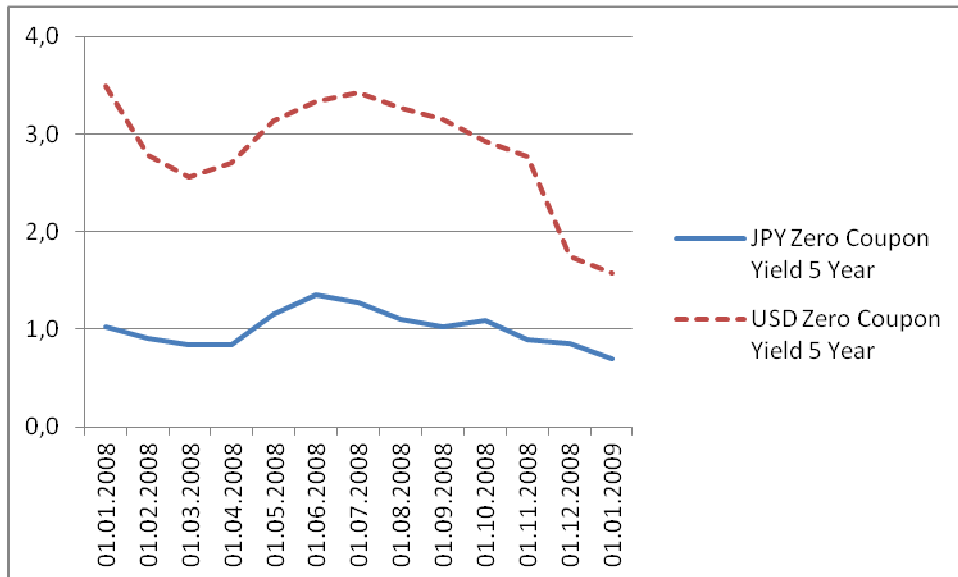

In contrast, over the year 1999 these interest rates tended to move in different directions:

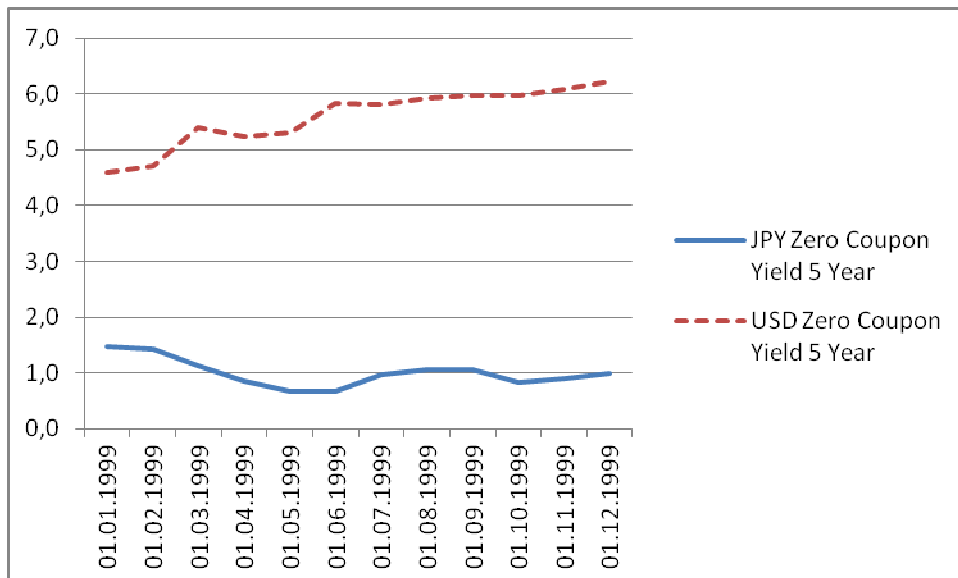

For the partial risk factor approach, the buckets, and the risk weights (i.e., the standard deviations multiplied by a common scalar) and the correlation within and across buckets will be primarily calibrated to a particular year of stress. The year to which the partial risk factor approach would be calibrated would likely include the last four months of 2008, which saw the collapse of Lehman Brothers. Of course, the Committee will also exercise its judgement, but in particular the correlations implied by that year's data may establish the basis for the capital

charges. This leads to a concern that calibration may be driven largely by episodes where losses have been caused largely by credit risk, although traded credit may be a main source of risk only for some of the internationally active banks. For others the main risks from their trading activities may be interest rate risk and foreign risk.

For the models-based approach, the selection of the stress period depends on the composition of the bank's portfolio. For example, when a bank is vulnerable to changes of these rates in opposite directions (e.g., because its portfolio is dominated by a carry trade where the bank funds itself long-term in JPY and invests long-term in USD), the stressed expected shortfall may refer to a year such as 1999 when the USD and JPY 5-year rates moved in different directions. This applies to the direct and the indirect method for identifying the stressed period (cf. section 4.5.2 of the CP).

For the calibration of our proposal, both episodes would be taken into account. The experience in 1999 would serve as a warning that even the long-term interest rates of the major reserve currencies could move in opposite directions. Estimates for the standard deviations of the risk factors that are based on different periods would be blended. For example, the standard deviations for the residual risk of shifts to the domestic interest rates (level II of the hierarchy) could be increased relative to the estimate for 2008 (and perhaps the standard deviation of the worldwide level of interest rates at level I of the hierarchy reduced). This would reduce the hedging benefit for risk positions of opposite sign in interest rates for different currencies. In this way hedging recognition would be limited to hedges that have shown to be reasonably robust over time. Note again that a fair amount of judgement may have to be applied in particular to neutralise the effect of government intervention in managed exchange rates and interest rates, should the Committee ultimately pursue this route.

Even with this partly "manual" approach for calibration, the transparency, and mathematical consistency, of the variance covariance matrix could easily be maintained, as all entries, except the variances on the main diagonal, are zero. In this way, the use of independent risk factors would in particular enable the Committee to use its judgment on the robustness of certain hedges in a structured way.

3 The three steps in formal notation

This section describes the three steps for calculating the capital charge for the risk factor classes equity risk, interest rate risk, FX risk, and commodity risk in formal notation. As outlined in section 4.2 of the pro-

posal the description reads across to credit spread risk when the assumption of normally distributed risk factor shocks is dropped.

3.1 Step 1: mapping to the risk factors

The partial risk factor approach, the models-based approach and the proposal all rely on a joint distribution of risk factors. A principal difference between the three approaches lies in what they regard as risk factors. The following table provides an overview:

Principal choices for the risk factors by approach	
Approach	Risk factors
partial risk factor approach	return on the market price of the instrument i
models-based approach	return ²² on underlying pricing parameters p_i
this proposal on the specification of the fuller risk factor approach	return on independent risk factors RF_j

By the pricing parameter p_i we mean a single positive real number, or a vector of positive real numbers, that is relevant for the valuation of the instrument i .

The regulator-specified risk factors of the proposal shock the pricing parameters. The range of pricing parameters that is shocked by a risk factor depends on the level of the risk factor in the hierarchy. Through this specification, in combination with the calibrated distributions of the risk factors, the proposal implicitly generates a dependence pattern for the underlying pricing parameters. Under the models-based approach, the bank would estimate the correlations directly for each pair of risk factors.

For our proposal, the bank must employ a two-step mapping process: For each instrument it must (1.) identify the pricing parameters p_i , and (2.) identify the risk factors that shock the p_i . The bank must also pro-

²² Sometimes, in particular for interest rate risk, banks may not set up risk factors up as relative changes (returns) to pricing parameters, but as absolute changes.

vide a proper “interface” between the regulator-imposed risk factors and its own pricing parameters. Formally, the bank must use pricing parameters p_i such that $MV_i((1+c_j) \cdot p_i)$, the value of instrument i given a (deterministic) shift $c_j \neq 0$ to the j -th risk factor, would be a well-defined expression. The following examples illustrate this task.

For instruments that are linear in equity risk, commodity risk and foreign exchange risk, the risk factors shock the spot price of the equity, the spot price of the commodity²³ or the exchange rate, respectively. These prices are parameters that a bank would use anyway. The expression $MV_i((1+c_j) \cdot p_i)$ should be well-defined in all cases.

For instruments that banks generally value using pricing models, the bank may have to map the pricing parameters that it uses for internal purposes to pricing parameters that it uses to determine the capital charge. For example, the risk factors for interest rate risk shock the forward rates for the intervals 0 to 1 years, 1 to 4 years and beyond 4 years. This means that the bank must express the value of a bond

1. as a function of default-free instantaneous forward rates (“forward rates”, for short) - and not e.g. as a function of yields; and
2. as a function of forward rates that do not straddle any two of the three intervals. (Example: if a bank uses a forward rate for the interval 3 to 5 years it would have to break this up into two forward rates: one for 3 to 4 years, and another for 4 to 5 years. Only the break-up makes the expression $MV_i((1+c_j) \cdot p_i)$ well-defined.)

3.2 Step 2: gross and net risk positions

In this section we first provide a definition for the size of the *gross* risk position. This is illustrated by two examples for instruments that are linear in risk factors. We then specify the definition of the size of the gross risk position further for instruments that are non-linear in a risk factor. An example is provided here as well. A definition of the size of the *net* risk position concludes the section.

²³ If forward contracts are more actively traded, the bank could also use its pricing model to derive a “quasi-spot price” from a more liquid forward price.

Seite 41 | 76

The size $size_{ij}^{(m)}$ of the **gross risk position** from instrument i with respect to the j -th risk factor given a (deterministic) shift $c_j^{(m)}$ of this risk factor is defined in expression (4) in section 2 of the proposal.

A modified definition is applied only to the level III risk factors for general interest rate risk ("shock to slope of money market/swap rate curve in respective currency (residual)"): here the shift $c_j^{(m)}$ applies to the forward rates for the interval 0 to 1 year with a negative sign and to the forward rates beyond 4 years with a positive sign (for details, see Example 2 in Annex 2).

The $size_{ij}^{(m)}$ can be expressed in words as the change in value of instrument i in units of currency per unit of relative change to the j -th risk factor. It signifies the sensitivity of value of instrument i w.r.t. a relative change in risk factor j . This specification of the size of the gross risk position is chosen for the following reason:

On the one hand, the risk factors RF_j are set up as a random shock in the form of **relative** changes to a pricing parameter p_i . This ensures that the shocked pricing parameters remain positive. Estimates for standard deviations of relative changes of pricing parameters tend to depend less on the level of a pricing parameter than standard deviations of absolute changes, unless pricing parameters are close to zero.²⁴ On the other hand, the capital charge is a potential change in value of the portfolio. This is expressed **in currency units**.

The definition of the size of the risk position provides the link between the random shocks to the pricing parameters, and the change in value of the portfolio: the expression $size_{ij}^{(m)} \cdot RF_j$ is a random variable that signifies a random change in value of the portfolio (in units currency) that stems from applying a relative change, the random shock RF_j , to a pricing parameter p_i that is relevant for the value of instrument i .

For an instrument that is strictly linear in the j -th risk factor, (e.g., a cash equity) the size of the gross risk position does not depend on the shift $c_j^{(m)}$ (see Example 1 below).

For an instrument that is linearised in the j -th risk factor, in principle, a single small shift c_j is used. As c_j approaches zero, $size_{ij}$ converges to

²⁴ In practice pricing parameters (e.g. forward rates) may be close to zero, occasionally even negative. In order to still produce substantial capital charges in such a situation, the rules would include floors for pricing parameters, in particular forward rates.

Seite 42 | 76

the first partial derivative in expression (5) in section 2 of our proposal. This shift is therefore used as the size of the gross risk position when an instrument is linearised in the j -th risk factor.

For an instrument that is non-linear in a risk factor, six different shifts $c_j^{(m)}$ are applied in parallel, $m \in \{1, 2, 3, 4, 5, 6\}$. This means that six sizes $size_{ij}^{(m)}$ are determined for the risk factor with respect to the instrument i .

To illustrate the size of the gross risk position from an instrument that is **strictly linear** in all risk factors, we consider an equity denominated in a foreign currency (Example 1). A bond denominated in the reporting currency is used as an example for a **linearised** instrument (Example 2).

Example 1: equity denominated in a foreign currency

The market value of an equity that is denominated in a foreign currency is given by $p_{FX} \cdot p_{eq} \cdot n_{eq}$, where p_{FX} the exchange rate (in units of reporting currency per unit of foreign currency), p_{eq} the share price in the foreign currency and n_{eq} the number of equities held.

The size of the gross risk position with respect to any risk factor RF_j that shocks the share price p_{eq} is given by

$$size_{ij} = \frac{p_{FX} \cdot p_{eq} \cdot (1 + c_j) \cdot n_{eq} - p_{FX} \cdot p_{eq} \cdot n_{eq}}{c_j} = p_{FX} \cdot p_{eq} \cdot n_{eq}, \quad (5)$$

i.e., it is the market value of the equity holding expressed in the reporting currency. The size of the shift rf_j is irrelevant.²⁵

²⁵ This definition for the size of the gross risk position means that implicitly equity betas are assumed to be homogeneous and equal to one. A beta other than one could be included by defining the size of a gross risk position as $\frac{MV_i((1 + \beta_{ij} \cdot rf_j) \cdot p_i) - MV_i(p_i)}{rf_j}$. In the example above, the size of the gross risk

position would then be $p_{FX} \cdot \beta_{eg,j} \cdot p_{eq} \cdot n_{eq}$, i.e. the market value of the equity times $\beta_{eg,j}$. This could however make the definition of the size less intuitive. And it is not obvious to what readily observable features the β_{ij} could be linked, i.e. what readily observable features could differentiate equities by beta. Therefore, for the time being betas of 1 are assumed. Note also that it is not an option for the revised standardised approach to rely on a bank's stochastic model.

Seite 43 | 76

Likewise, the size of the gross risk position with respect to any of the two risk factors RF_j that shock the exchange rate p_{FX} is given by

$$size_{ij} = \frac{p_{FX} \cdot (1 + c_j) \cdot p_{eq} \cdot n_{eq} - p_{FX} \cdot p_{eq} \cdot n_{eq}}{c_j} = p_{FX} \cdot p_{eq} \cdot n_{eq}, \quad (6)$$

i.e., it is again the market value of the equity holding expressed in the reporting currency. Again the size of the shift c_j is irrelevant. It may be worth noting that this result also holds with respect to the risk factor at level I of the hierarchy, which shocks the exchange rate of domestic currency to a worldwide currency basket (e.g., special drawing rights (SDR)). Note further that an option denominated in a foreign currency whose underlying does not include an exchange rate as a risk factor is treated as linear in either of the two risk factors for foreign exchange risk.

The aforementioned general definition of the size of the gross risk position applies to any risk factor (except for the slope of the interest rate curve). The example of an FX equity is included to provide comfort that the above definition for the size of the gross risk position is "natural" and that, with one exception, it can be used throughout to operationalise the concept of a "size of the gross risk position". For an equity denominated in a foreign currency, there is actually no difference to the current standardised measurement method and the partial risk factor approach: they also measure the size of the risk position with respect to equity risk and foreign exchange risk as the market value, converted to the reporting currency.

Example 2: zero-coupon bond

The market value of a zero-coupon bond i denominated in the reporting currency is given by

$$MV_i = \exp \left(\sum_{k \in K_{(0,1]} \cup K_{(1,4]} \cup K_{(4,\infty)}} - (p_{rate,k} + p_{cs_obl,k} \cdot p_{lgd,k} + p_{other,k}) \Delta t_k \right) \cdot CF, \quad (7)$$

where the term to maturity of the cash flow CF is decomposed into time intervals Δt_k , and the following definitions apply:

Seite 44 | 76

- $P_{rate,k}$ is the default-free instantaneous forward rate for the k-th time interval ("the" forward rates),²⁶
- $P_{cs_obl,k}$ is the defaultable instantaneous forward rate for the obligor for the k-th time interval with a loss given default of 100% (i.e., a purely obligor-related credit spread)
- $P_{lgd,k}$ is the (market-implied) loss given default for the k-th time interval ($P_{cs_obl,k} \cdot P_{lgd,k}$ is the instantaneous forward credit spread for the k-th time interval), and
- $P_{other,k}$ is some other spread that is relevant for the valuation of the zero-coupon bond.
- $K_{(0,1]}$ is the set of the indices k that identifies the time intervals that combine to the time interval (0,1] years. $K_{(1,4]}$ and $K_{(4,\infty]}$ are defined analogously.

Interest rate risk:

Levels I and II:

For the size of the gross risk position with respect to the risk factor "shock to worldwide interest rate index (e.g., SDR interest rate)" (level I) and the risk factor "shock to level of money market/swap rate curve in the currency (residual)" (level II) expression (5) in section 2 becomes:

²⁶ As stated in section 2 of the proposal: In some cases (e.g., currently for certain interest rates) the level of the pricing parameter that is shifted by a certain risk factor may be so low that insufficient capital charges would result. This could mean that a floor or a flat value would be used e.g. for an interest rate for determining the size of the risk position. In this case the market value MV_i of the instrument would remain unchanged. Only the pricing parameters by which it is multiplied would be floored, or replaced by flat value. To use a flat value would be equivalent to expressing the standard deviations of the shocks to pricing parameters in percentage point changes to the interest rates, not as relative changes. The assessment of whether this is desirable for the rather diverse levels of interest rates world-wide would have to be made based on empirical analysis.

$$\begin{aligned}
 size_{ij} &= \frac{\partial \exp \left(\sum_{k \in K_{(0,1]} \cup K_{(1,4]} \cup K_{(4,\infty)}} - (p_{rate,k} \cdot (1 + c_j) + \dots) \Delta t_k \right) \cdot CF}{\partial c_j} \\
 &= MV_i \cdot \left(\sum_{k \in K_{(0,1]} \cup K_{(1,4]} \cup K_{(4,\infty)}} - p_{rate,k} \cdot \Delta t_k \right)
 \end{aligned} \tag{8}$$

Level III:

The risk factor “shock to slope of money market/swap rate curve in the currency (residual)” shocks the forward rates beyond 4 years in the opposite direction than the shock to the forward rates for the interval 0 to 1 years. The forward rates for the interval 1 to 4 years remain unchanged.

For the level III risk factors for interest rate risk (there is one for each currency), the size of the gross risk position is:

$$size_{ij}^{(m)} = \frac{\partial MV_i \left((1 - c_j) \cdot p_{i,(0,1]}, (1 + c_j) \cdot p_{i,(4,\infty)} \right) - MV_i(p_i)}{\partial c_j}, \tag{9}$$

where $p_{i,(0,1]}$ is the forward rate (or vector of forward rates) for the time interval 0 to 1 year, and $p_{i,(4,\infty)}$ is the (vector of) forward rate(s) for the time interval beyond 4 years.

In the example of the zero-coupon bond, the size of the gross risk position is then

$$\begin{aligned}
 size_{ij} &= \frac{\partial \exp \left(\sum_{k \in K_{(0,1]}} - (p_{rate,k} \cdot (1 - c_j)) \Delta t_k + \dots + \sum_{k \in K_{(4,\infty)}} - (p_{rate,k} \cdot (1 + c_j)) \Delta t_k \right) \cdot CF}{\partial c_j} \\
 &= MV_i \cdot \left(\sum_{k \in K_{(0,1]}} p_{rate,k} \cdot \Delta t_k - \sum_{k \in K_{(4,\infty)}} p_{rate,k} \cdot \Delta t_k \right)
 \end{aligned} \tag{10}$$

Level IV and non-hedgeable risk factors:

For the size of the gross risk position with respect to a risk factor “shock to money market/swap rate between vertex points in respective curren-

Seite 46 | 76

cy (residual)" (as risk factor at level IV, or as a non-hedgeable risk factor) expression (5) in section 2 becomes

$$\begin{aligned} size_{ij} &= \frac{\partial \exp\left(\sum_{k \in K_{interval}} -(p_{rate,k} \cdot (1 + c_j) + \dots) \Delta t_k\right) \cdot CF}{\partial c_j}, & (11) \\ &= MV_i \cdot \left(-\sum_{k \in K_{interval}} p_{rate,k} \cdot \Delta t_k\right) \end{aligned}$$

where the index "interval" in $K_{interval}$ refers to the reference time interval of the forward rates that the j-th risk factor shocks, i.e., intervals 0 to 1 years, 1 to 4 years or beyond 4 years.

Credit spread risk:

For the size of the gross risk position with respect the risk factors for credit spread at any level of the hierarchy, including the non-hedgeable risk factor expression (5) in section 2 becomes:

$$\begin{aligned} size_{ij} &= \frac{\partial \exp\left(\sum_{k \in K_{(0,1]} \cup K_{(1,4]} \cup K_{(4,\infty)}} -(\dots + p_{cs_obl,k} \cdot (1 + c_j) \cdot p_{lgd,k} + \dots) \Delta t_k\right) \cdot CF}{\partial c_j} & (12) \\ &= MV_i \cdot \left(\sum_{k \in K_{(0,1]} \cup K_{(1,4]} \cup K_{(4,\infty)}} -p_{cs_obl,k} \cdot p_{lgd,k} \cdot \Delta t_k\right) \end{aligned}$$

Note again that credit spreads, like interest rates, could be so low that insufficient capital charges would result. They could even be negative. Whilst the pricing parameter would remain unchanged for the valuation of the instrument, it could be floored at a certain absolute level when it comes to determining the size of the gross risk position. The standard deviation for a risk factor that applies to the pricing parameter would then be multiplied by the pricing parameter at the level of the floor.

For an instrument i that is **non-linear** in the j-th risk factor, the size of the gross risk position depends on the size of the shift $c_j^{(m)}$. Specifically, the proposal uses six shifts $c_j^{(m)}$, $m \in \{1, 2, 3, 4, 5, 6\}$, for an instrument

Seite 47 | 76

that is non-linear in a risk factor. The size $size_{ij}^{(m)}$ of the gross risk position given a shift $c_j^{(m)}$ is determined according to the general definition for the size of the gross risk position in expression (4) from section 2 of our proposal. For level III risk factors for interest rate risk (“shock to slope of money market/swap rate curve in respective currency (residual)”) the special definition in expression (11) applies.

– The range of the potential realisations of the j-th risk factor is subdivided into m intervals $I_j^{(m)}$. $c_j^{(m)} = E(RF_j | RF_j \in I_j^{(m)})$ is defined as the expected value of the j-th risk factor on the condition that the j-th risk factor assumes a value from the m-th interval.²⁷

For all risk factors, except those for credit spread risk, **normality** is assumed. The shifts $c_j^{(m)}$ are specified as simple multiples of the standard deviation.

For the standard normal distribution $Z \sim N(0,1)$, six intervals $I^{(m)}$ are specified such that the conditional expectations satisfy the following

$$a_m = E(Z | Z \in I^{(m)}) = \frac{1}{q^{(m)}} \int_{I^{(m)}} z \varphi(z) dz, \quad (13)$$

where $q^{(m)} := P(Z \in I^{(m)})$ and φ is the density of Z . The a_m take on the following values: $(a_1, a_2, a_3, a_4, a_5, a_6) = (-2.5, -1.5, -0.5, 0.5, 1.5, 2.5)$. Technically, the values for a_2, a_3, a_4 and a_5 were imposed judgementally. From this, the boundaries of the intervals $I^{(m)}$ were determined numerically, imposing a value of zero for the boundary “in the middle” due to the symmetry of the standard normal distribution.²⁸ The a_1 and a_6 were then found numerically as well. They happen to line up neatly with the imposed values for a_2, a_3, a_4 and a_5 . For each interval the conditional expectation b_m of the squared standard normal is also determined numerically,

²⁷ In the case of credit spread risk, the six shifts $C_j^{(m)}$ are applied irrespective of whether an instrument is linear or non-linear in a risk factor. This is done to capture the assumed skewness of the distribution of the relevant risk factors.

²⁸ The boundaries are $(-2.19, -1.10, 0, 1.10, 2.19)$. They do not immediately enter the calculation of the capital charge. They are provided for information nonetheless.

$$b_m = E\left(Z^2 \mid Z \in I^{(m)}\right) = \frac{1}{q^{(m)}} \int_{I^{(m)}} z^2 \cdot \varphi(z) dz, \quad (14)$$

Table 2 lists the results:

Table 2

Parameters for the local linearisation of non-linear instruments

# interval	1	2	3	4	5	6
a_m	-2.5	-1.5	-0.5	+0.5	+1.5	+2.5
b_m	6.6	2.3	0.3	0.3	2.3	6.6
q_m	0.0143	0.1214	0.3643	0.3643	0.1214	0.0143

With respect to its marginal distribution, each random variable RF_j can be written as the product of a standard normal random variable and the standard deviation σ_j that is calibrated for the risk factor., so that $RF_j = \sigma_j \cdot Z$ for all j .²⁹ The expectation of the risk factor RF_j , conditional on the event $RF_j \in I_j^{(m)}$, is then equal to $\sigma_j \cdot a_m$. The latter observation follows from a general property of the expectation operator: $E(uX) = uE(X)$, where X is a random variable and $u \in \mathbb{R}$. The probability of the event $RF_j \in I_j^{(m)}$ is the same as for the corresponding event $Z \in I^{(m)}$, i.e. $P(RF_j \in I_j^{(m)}) = q^{(m)}$ for all risk factors.

In summary, for all risk factors - except those for credit spread risk - the shifts $c_j^{(m)}$ are given by

$$c_j^{(m)} = \sigma_j \cdot a_m, \quad (15)$$

The conditional expected values of the squared random variables, which are used to determine the contribution of the j -th risk factor to the overall variance of the portfolio in step 3 (see formula 2 in section 2 of the proposal) are analogously given by

²⁹ For the joint distribution of the RF_j the independence of the risk factors of any risk factor class must, of course, be observed as well.

$$d_j^{(m)} = \sigma_j \cdot b_m, \quad (16)$$

Note that the shifts $c_j^{(m)}$ are regarded as representative for all potential realisations in the m -th interval $I_j^{(m)}$, i.e. the size of the gross risk position $size_{ij}^{(m)}$ is used for all potential realisations in $I_j^{(m)}$, although it is actually determined just for their conditional expected value $c_j^{(m)}$. This is a key assumption of the approximation through “local linearisation”.

Example 3: equity option denominated in domestic currency

The size of the gross risk positions is determined separately with respect to the risk factors that shock the price of the underlying equity and the risk factors that shock the implied volatility. For simplicity, our proposal recognises curvature only with respect to the risk factors that shock the pricing parameters for the underlying. The approximation through local linearisation could however easily be extended to risk factors that shock the implied volatility.

The expressions (17) and (19) below apply to the relevant risk factors at all levels of the hierarchy, including the non-hedgeable risk factors. Note however that the shifts $c_j^{(m)}$ in expression (17) may differ across risk factors for given interval number m as different standard deviations (i.e. risk weights) may apply to different risk factors.

Shocks to the price of the underlying

The size of the gross risk position from an equity option with market value $MV_i(p_i)$ ³⁰ with respect to a risk factor j that shocks the price of the underlying equity, given the shift $c_j^{(m)}$ to this risk factor, is

$$size_{ij}^{(m)} = \frac{MV_i\left(\left(1 + c_j^{(m)}\right) \cdot p_i\right) - MV_i(p_i)}{c_j^{(m)}}. \quad (17)$$

This expression is identical to the expression (4) in section 2 of the proposal. It is akin to the delta of an option that is expressed in units of currency, but the shift $c_j^{(m)}$ is used instead of the infinitesimally small shift for the delta.

³⁰ p_i is the vector of all pricing parameters that the bank uses to value the option. It includes namely the price of the underlying equity and the implied volatility.

Seite 50 | 76

An equivalent expression is

$$size_{ij}^{(m)} = \frac{MV_i\left(\left(1 + c_j^{(m)}\right) \cdot p_i\right) - MV_i(p_i)}{c_j^{(m)} \cdot MV_i(p_i)} \cdot MV_i(p_i). \quad (18)$$

The quotient is what is referred to as a “secant slope” in this note. It has an interpretation as the change in value of one option *per Euro change* to the underlying equity given the shift $c_j^{(m)}$. Its dimension is “number of equities”. It is akin to the delta of an option that is expressed as a number of shares. (An analogous term for this delta would be “tangent slope”.)

Shocks to the implied volatility

We linearise the market value of the option as a function of the implied volatility. According to expression (5) in section 2 the size of the gross risk position from the equity option with respect to a risk factor j that shocks the implied volatility to this risk factor is

$$\begin{aligned} size_{ij} &= \frac{\partial MV_i\left(\left(1 + c_j\right) \cdot p_i\right)}{\partial c_j} \\ &= \frac{\partial MV_i\left(\left(1 + c_j\right) \cdot p_i\right)}{\partial p_{ik}} \cdot p_{ik} \end{aligned} \quad (19)$$

where p_{ik} is the implied volatility. $\frac{\partial MV_i\left(\left(1 + c_j\right) \cdot p_i\right)}{\partial p_{ik}}$ is the vega of the option.³¹ Banks may use different implied volatilities to value options of the same underlying equity in order to recognise smile effects. Expression (19) applies notwithstanding as for each option there would still be a single implied volatility.

The size of a **net risk position** is determined as follows: For each risk factor the sizes of the gross risk positions are aggregated separately for each of the six intervals $I_j^{(m)}$. This ensures that the sizes of the gross risk positions are aggregated in a **scenario-consistent, and risk-sensitive** way. This approach leads to the specification of the size of net

³¹ The partial derivative is determined at $C_j = 0$. Therefore it is correct to use C_j as the denominator of the outer derivative.

Seite 51 | 76

risk position with respect to the j -th risk factor given a shift $c_j^{(m)}$ (i.e. conditional on the event $RF_j \in I_j^{(m)}$) according to expression (3) in section 2 of the proposal. The size of the gross risk positions from an instrument that is linear or linearised in the j -th risk factor would of course be the same for each of the shifts $c_j^{(m)}$, i.e. the size of the gross risk position from an instrument that is linear in a risk factor would have to be determined only once.

When all instruments are linear or linearised in a risk factor, the sizes of the gross risk positions, and hence the sizes of all net risk positions, are the same for all intervals. The size $size_j$ of net risk position with respect to the j -th risk factor is given by

$$size_j = \sum_i size_{ij} . \quad (20)$$

3.3 Step 3: capital charge

Sub-step (a) of the calculation of the capital charge concerns the **variance** that the j -th risk factor contributes to the overall variance of the change in value of the portfolio (the “contribution of the j -th risk factor”).

When all instruments in the portfolio are **linear** (or linearised) with respect to the j -th risk factor, the contribution of risk factor j is determined as

$$Var\left(\sum_i \Delta_j MV_i(RF_j)\right) = (size_j \cdot \sigma_j)^2 . \quad (21)$$

This follows directly from the definition of the size of the net (and the gross) risk position with respect to a risk factor.

When at least one instrument is **non-linear** with respect to the j -th risk factor the contribution of the j -th risk factor is determined as follows:

The formal expression for the expected contribution of the j -th risk factor using the approximation through local linearisation is

$$E\left(\sum_i \Delta_j MV_i(RF_j)\right) \quad (22)$$

Seite 52 | 76

$$\begin{aligned}
 &= \sum_{m=1}^6 E\left(\sum_i \Delta_j MV_i(RF_j) \mid RF_j \in I_j^{(m)}\right) \cdot q_m \\
 &\approx \sum_{m=1}^6 E\left(\text{size}_j^{(m)} \cdot RF_j \mid RF_j \in I_j^{(m)}\right) \cdot q_m \\
 &= \sum_{m=1}^6 \text{size}_j^{(m)} \cdot c_j^{(m)} \cdot q_m
 \end{aligned}$$

The formal expression for the expected squared contribution of the j-th risk factor using again the approximation through local linearisation is:

$$\begin{aligned}
 &E\left(\left(\sum_i \Delta_j MV_i(RF_j)\right)^2\right) \\
 &= \sum_{m=1}^6 E\left(\left(\sum_i \Delta_j MV_i(RF_j)\right)^2 \mid RF_j \in I_j^{(m)}\right) \cdot q_m \\
 &\approx \sum_{m=1}^6 E\left(\left(\text{size}_j^{(m)} \cdot RF_j\right)^2 \mid RF_j \in I_j^{(m)}\right) \cdot q_m \\
 &= \sum_{m=1}^6 \left(\text{size}_j^{(m)}\right)^2 \cdot d_j^{(m)} \cdot q_m
 \end{aligned} \tag{23}$$

The variance of a random variable X can be written using two expectations: $\text{Var}(X) = E(X^2) - (E(X))^2$. Applying this to $\sum_i \Delta_j MV_i(RF_j)$ we get the formula (2) in section 2 of the proposal for the contribution of the j-th risk factor.

The term “**local linearisation**” for this approximation is used for the following reason: conditional on the event $RF_j \in I_j^{(m)}$, we set $\sum_i \Delta_j MV_i(RF_j) := \text{size}_j^{(m)} \cdot RF_j$ in expressions (22) and (23). In other words: conditional on this event we treat the change in value of the portfolio that is attributed to the j-th risk factor as if it were linear in RF_j .

Seite 53 | 76

The further sub-steps of step 3 are:

- (b) sum the variances from step (a) across all risk factors;
- (c) take the square root of the sum from step (b); and
- (d) multiply the square root from step (c) by a scalar.

Formally, the result of these sub-steps can be expressed by formula (1) in section 2 of the proposal.

The summing of the variances recognises **diversification** across risk factors.

Annex 2: Worked examples

Throughout this annex the following two examples are considered:

Example 1: The bank holds 1,000 Daimler shares at a price of €101 per share, and has sold 500 Volkswagen shares under a forward contract that matures in one year. The current Volkswagen share price is €20;

Example 1a: The bank also hedges its exposure to the Daimler share price by buying 2,000 put options on the Daimler shares, with a strike price of €100 and one-year maturity;

Example 2: A Brazilian bank takes (i) a single USD 100 million 9 month deposit (assuming the deposit is in the trading book) to fund the purchase of (ii) a single GBP 62 million (USD 100 million equivalent at current FX rates, or BRL 172 million) six-year UK Gilt. The Gilt is a zerobond.³²

Example 2a: The Real-based bank adds the following cross-currency swap to the portfolio in Example 2: (i) receiving leg in USD; (ii) paying leg in GBP. The contract is a fixed-to-fixed five-year contract with a notional value of USD 100 million (or its equivalent to corresponding FX rates) and its current mark-to-market value is zero.

The first example illustrates the treatment of equity risk, and generally the recognition of hedging.³³ In a first round, only instruments that are linear in all risk factors are included. Example 1a is an extension of the first in that it includes an option as well.

The second example introduces the treatment of interest risk FX risk, and credit risk.

It should be noted that the examples below include standard deviations for the risk factors for step 3 (a) and the overall scalar for step 3 (d) of the calculation of the capital charge. The purpose of specifying certain parameters is purely to illustrate the mechanics of the proposal. These parameters should in no way be taken as indicative of the result of a future calibration of the proposal. For step 3 the sub-steps (a) to (d) are referenced in the relevant columns or rows.

³² This is the same example as in section 4 of Annex 6 of the CP, except that for simplicity the six-year UK gilt is assumed to be a zerobond.

³³ The payment leg of the forward sale is subject to interest rate risk. This is disregarded here for simplicity. The counterparty credit risk and CVA risk from the forward would be treated according to the Basel III.

Example 1: Cash equities

Step 1:

The following risk factors are applicable to the Daimler shares and the Volkswagen shares:

Level	Equity risk: risk factors applica- ble to Daimler share	Equity risk: risk factors applica- ble to Volkswagen share
I	worldwide equity index	worldwide equity index
II	equity index e.g., for non-bank equities (re- sidual)	equity index e.g., for non-bank equities (re- sidual)
III	price of Daimler share (residual)	price of Volkswagen share (residual)
non- hedge- able	none	price of Volkswagen share (residual)

The Daimler shares are cash equities. For them all risk factors are hedgeable. The Volkswagen shares are however sold under a forward contract, i.e., they are part of a derivative contract. A non-hedgeable risk factor is therefore included for the risk factor class "equity".³⁴ Specifically a risk factor "shock to price of Volkswagen share (residual)" is used as the risk factor at the lowest level of the hierarchy of hedgeable risk factors, and as a non-hedgeable risk factor.

Step 2:

The sizes of the gross risk positions from the risk factors for equity risk that are applicable to the Daimler and Volkswagen shares are:

³⁴ Non-hedgeable risk factors would be included for all risk factor classes that are relevant for the instrument. For the equity forward this would mean that non-hedgeable risk factors for interest rate risk are included as well.

Level	Daimler	Size of gross risk position	Volkswagen	size of gross risk position
I	worldwide equity index	€101,000	worldwide equity index	€-10,000
II	equity index e.g., for non-bank equities (residual)	€101,000	equity index e.g., for non-bank equities (residual)	€-10,000
III	price of Daimler share (residual)	€101,000	price of Volkswagen share (residual)	€-10,000
n-h ³⁵	none	none	price of Volkswagen share (residual)	€-10,000

The sizes of the gross risk positions with respect to the applicable risk factors at all levels are determined as: number of shares (e.g., Daimler: 1,000) multiplied by the share price (e.g., Daimler: €101).

The sizes of the net risk positions from the risk factors for equity risk that are applicable to the Daimler and Volkswagen shares are:

Level	risk factor	size of net risk position
I	worldwide equity index	€91,000
II	equity index e.g., for non-bank equities (residual)	€91,000
III	price of Daimler share (residual)	€101,000
III	price of Volkswagen share (residual)	€-10,000
n-h	shift to price of Volkswagen share (residual)	€-10,000

The risk factors "shock to worldwide equity index" (level I) and "shock to equity index e.g., for non-bank equities (residual)" (level II) are applicable to both shares. The size of the net risk position for these risk fac-

³⁵ "n-h" is an abbreviation for "non-hedgeable risk factor".

tors is determined as the sum of the sizes of the gross risk positions. For example, the interpretation for the risk factor “shock to equity index, e.g., for non-bank equities (residual)” is that the bank is exposed to a first gross risk position of non-bank equities of the size €+101,000, and a second gross risk position of non-bank equities of the size €-10,000, such that the size of the net risk position is €91,000.

Step 3:

Level I	Equity risk: portfolio	size of risk position (EUR)	standard deviation of risk factor	sign* standard deviation of risk position (EUR)	contribution of the risk factor (EUR ²) (a)
I	worldwide equity index	91,000	10%	9,100	82,810,000
II	equity index e.g., for non-bank equities (residual)	91,000	10%	9,100	82,810,000
III	price of Daimler share (residual)	101,000	10%	10,100	102,010,000
III	price of Volkswagen share (residual)	-10,000	10%	-1,000	1,000,000
n-h	price of Volkswagen share (residual)	-10,000	10%	-1,000	1,000,000
portfolio	portfolio variance (EUR ²) (b)				269,630,000
portfolio	portfolio standard deviation (EUR) (c)				16,420
portfolio	expected shortfall (EUR) (d)				65,682

For sub-step (d), the expected shortfall is assumed to be four times the standard deviation of the change in value of the portfolio.

In order to determine the bank’s capital charge for market risk, the ES for equity risk would have to be combined with the ES for interest rate

from the payment leg of the forward sale according to a variant of the aggregation scheme of the models-based approach (see formula (1) in section 4.5.6 of the CP).

Example 1a: Equity option

Step 1:

The risk factors that are applicable to the put option on Daimler shares are:

Level	Equity risk: risk factors applicable to the <i>underlying</i> of the put option on Daim- ler shares	Equity risk: risk factors applicable to the <i>implied volatility</i> of the put option on Daim- ler shares
I	worldwide equity index	worldwide index for implied volatilities for equities
II	equity index e.g., for non-bank equities (residual)	index of implied volatilities e.g., for non-bank equities (residual)
III	price of Daimler share (residual)	implied volatility of Daimler share (residual)
non-hedgeable	price of Daimler share (residual)	implied volatility of Daimler share (residual)

In addition to the risk factors from the equity risk category in example 1, the put option is subject to risk factors for implied volatilities. For the sake of simplicity, we will assume that the hierarchy for the risk factors for the implied volatilities is the same as for the underlying share price.

According to the general design of our proposal the hedgeable risk factors at the lowest level of the hierarchy are used as non-hedgeable risk factors to address basis risk from the option with respect to the underlying equity, and the implied volatilities of other options on Daimler.

Step 2:

The sizes of the gross risk positions with respect to the risk factors applicable to the *underlying* of the put option on Daimler shares are:

Level	Equity risk: Daimler underlying	Size of gross risk position by interval					
		# interval	1	2	3	4	5
	shift (in number of standard deviations)	-2.5	-1.5	-0.5	+0.5	+1.5	+2.5
	for illustration: slope of secant (for given shift in number of standard deviations) ³⁶	-0.9	-0.6	-0.5	-0.4	-0.3	-0.1
I	worldwide equity index	€-181,800	€-121,200	€-101,000	€-80,800	€-60,600	€-20,200
II	equity index e.g., for non-bank equities (residual)	€-181,800	€-121,200	€-101,000	€-80,800	€-60,600	€-20,200
III	price of Daimler share (residual)	€-181,800	€-121,200	€-101,000	€-80,800	€-60,600	€-20,200
n-h	price of Daimler share (residual)	€-181,800	€-121,200	€-101,000	€-80,800	€-60,600	€-20,200

As an example, consider the size of the gross risk position with respect to the risk factor “shock to worldwide equity index” (level I), given the shift that represents interval no. 1. This size is €-181,800. It is computed as the number of put options (2,000) multiplied by the size of the gross risk position per put option (€-90.9) for a shift to the risk factor of

³⁶ In this example, the slope of the secant by interval is same for all risk factors. This is based on the assumption of a uniform standard deviation for all risk factors, which is made for illustrative purposes only. It is likely that the calibration will result in different standard deviations at least for some of the risk factors. Different standard deviations will imply different secant slopes by interval across the risk factors.

Seite 60 | 76

-2.5 standard deviations, i.e. of $-25\% = 10\% \cdot (-2.5)$ where 10% is the standard deviation of a relative change of the Daimler price and -2.5 the number of standard deviations assumed for interval no. 1.

For illustration we have also included the slope of the secant expressed in numbers of shares (-0.9 for interval no. 1). This secant slope has an interpretation as the change in value of one option *per Euro change* to the Daimler price given the shift of $\text{€}-25.25 = \text{€}101 \cdot (-25\%)$ to the Daimler price. Using this secant slope the size of the gross risk position for interval no. 1 can also be written as $\text{€}-181,800 = 2,000 \cdot (-0.9) \cdot \text{€}101$. The secant slope is derived from the bank's pricing model.

The secant slope, or equivalently the size of the gross risk position, depends not only on the curvature of the option, but naturally also on the size of the shift that is applied to the Daimler share price. For example, the further the put option is in the money, given a shift, the closer will the secant slope be to -1. This means that the secant slope depends on the standard deviation to be specified for the relevant risk factors in the rules. For this worked example, however, we make the simplifying assumption that the standard deviations applying to all risk factors applying to the Daimler share price are the same (10%). This implies that for an interval of a given number a uniform vector of secant slopes, and uniform sizes of gross risk positions, will apply to all risk factors

The size of the gross risk position, given a certain shift, applies to all potential shocks to the risk factor from the interval that is represented by this shift. This design feature of our proposal is illustrated in Figure 7 below. It implies that the (random) change in value of an option is determined for each interval by multiplying the size of the gross risk position with the (random) shock to the risk factor.

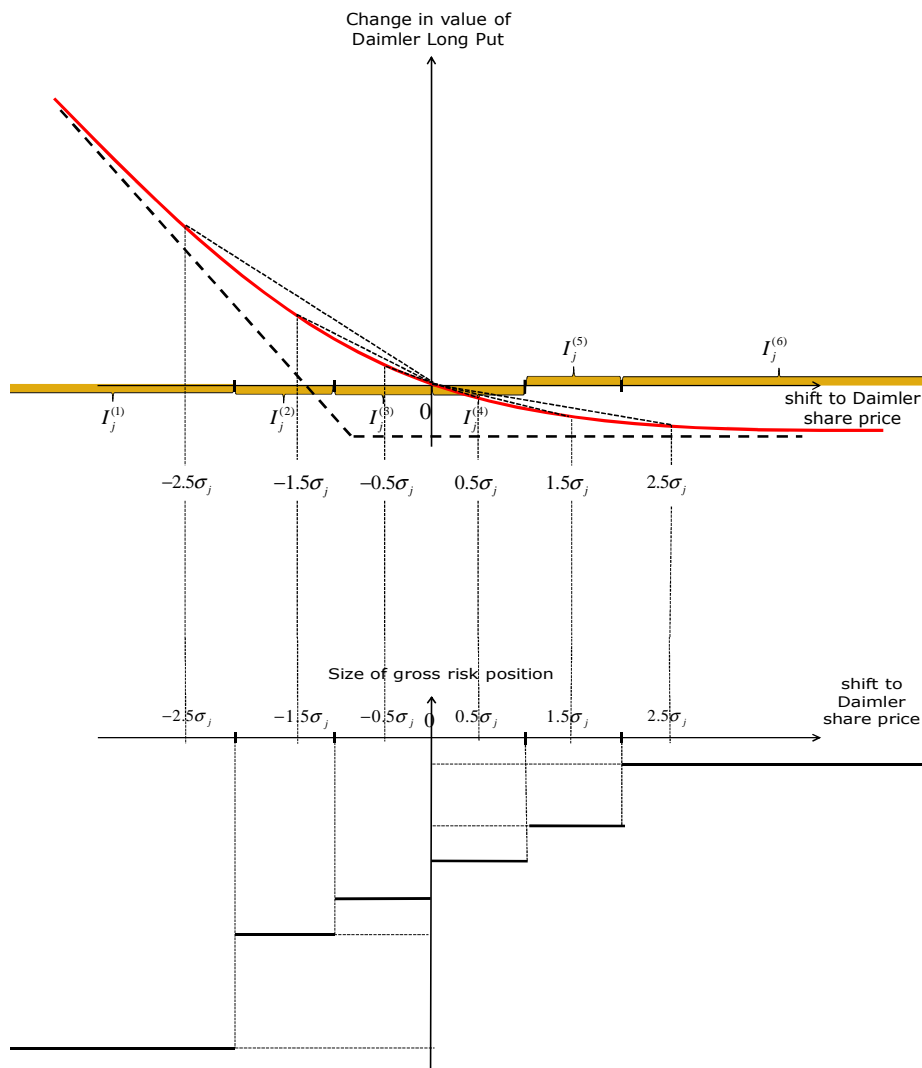

Figure 7: For any risk factor applicable to the underlying of the put option, the size of the gross risk position is determined for six (relative) shifts of the risk factor. It is same for all potential shock from the interval that is represented by the shift.

We now combine the put option on the Daimler shares with the Daimler and Volkswagen portfolio from Example 1. The sizes of the net risk positions with respect to the risk factors that apply to the Daimler or Volkswagen share prices are as follows:

Level	Equity risk: Daimler Volkswagen underlying	Size of net risk position by interval					
		# interval	1	2	3	4	5
I	worldwide equity index	€-90,800	€-30,200	€-10,000	€10,200	€30,400	€70,800
II	equity index e.g., for non-bank equities (residual)	€-90,800	€-30,200	€-10,000	€10,200	€30,400	€70,800
III	price of Daimler share (residual)	€-80,800	€-20,200	€ 0	€20,200	€40,400	€80,800
III	price of Volkswagen share (residual)	€-10,000	€-10,000	€-10,000	€-10,000	€-10,000	€-10,000
n-h	price of Daimler share (residual)	€-181,800	€-121,200	€-101,000	€-80,800	€-60,600	€-20,200
n-h	shift to price of Volkswagen share (residual)	€-10,000	€-10,000	€-10,000	€-10,000	€-10,000	€-10,000

By way of an example, consider the size of the net risk position of € 0 in the cell "shock to price of Daimler share (residual)" (risk factor of level III) and interval no. 3. The gross risk position from the put option on Daimler shares for this cell is €-101,000 (= number of options, i.e., 2,000, multiplied by the Daimler share price, i.e., €101, multiplied by slope of secant (-0.5)). The size of the gross risk position with respect to the risk factor "shock to price of Daimler share (residual)" (level III) from the cash Daimler shares is €101,000. The size of the gross risk position from the Volkswagen shares with respect to this risk factor is zero.

Seite 63 | 76

Note that for the non-hedgeable risk factor "shock to price of Daimler share (residual)" the size of the gross risk position for the portfolio is the same as for the put option, as this non-hedgeable risk factor relates to the put option only.

For the risk factors that relate to Volkswagen only ("shock to price of Volkswagen share (residual)" as level III risk factor, and as non-hedgeable risk factor) the size of the net risk position is of course the same for all intervals, as the Volkswagen shares are linear instruments.

The sizes of the gross risk positions from the risk factors that are applicable to the *implied volatility* of the put option on Daimler shares are:

Level	Daimler <i>implied volatility</i>	size of gross risk position
I	worldwide implied volatility index for equities	€100
II	Implied volatility index e.g., for non-bank equities (residual)	€100
III	implied volatility of Daimler share (residual)	€100
non-hedgeable	implied volatility of Daimler share (residual)	€100

For each of the risk factors the size of gross risk position from the Daimler shares with respect to the risk factors for *implied volatility* is €100 (2,000 put options multiplied by a vega of 0.20 multiplied by the implied volatility of 25%). (The value of the option is linearised in the implied volatility.)

Step 3:

The results below refer to the full portfolio, i.e., the put option on Daimler shares, the Daimler cash equity, and the forward sale of Volkswagen shares. The results are shown only at the level of the variances.

Level	Daimler Volkswagen underlying	Standard deviation of risk factor	contribution of the risk factor (EUR²) (a)
I	worldwide equity index	10%	13,736,043
II	equity index e.g., for non-bank equities (residual)	10%	13,736,043
III	price of Daimler share (residual)	10%	14,384,305
III	price of Volkswagen share (residual)	10%	1,000,000
n-h	price of Volkswagen share (residual)	10%	1,000,000
n-h	price of Daimler share (residual)	10%	100,482,185

The first three risk factors are hedgeable risk factors for which the put option on Daimler shares affects the size of the net risk position. Relative to Example 1, the variance that these risk factors contribute to the overall variance of the portfolio is substantially reduced. This reflects the hedge impact of the put option on these three risk factors. The variance of the risk factor "price of Daimler share (residual)" as non-hedgeable risk factor shows the unmitigated effect of the put option. The Daimler cash equity is not relevant for this risk factor.

Level	Daimler <i>implied volatility</i>	standard deviation of risk factor	contribution of the risk factor (EUR ²) (a)
I	worldwide index for implied volatilities for equities	5%	25
II	index of implied volatilities e.g., for non-bank equities (residual)	5%	25
III	implied volatility of Daimler share (residual)	10%	100
n-h	implied volatility of Daimler share (residual)	10%	100

For each of the risk factors the size of gross risk position is €100. The variance of 25 in the first row is determined as the square of: €100 multiplied by 5%.

The capital charge is determined as:

Overall equity risk: Underlying and implied volatility

portfolio variance (EUR ²) (b)	144,338,826
portfolio standard deviation (EUR) (c)	12,014
expected shortfall (EUR) (d)	48,056

The variance of the change in value of the portfolio is the sum of the variances across all risk factors. This reflects, in particular, the assumption that, within a risk factor class, the risk factors for the underlying and the risk factors for implied volatility are assumed to be independent as well.

Relative to Example 1, the capital charge is lower, i.e., the hedge effect from the put option on Daimler with respect to the risk factors applicable to the Daimler share price dominates the additional risk from non-hedgeable basis risk from the option, as well as the vega risks posed by it.

Example 2: Deposit and bond

The calculations use information on the default-free instantaneous forward rates, the defaultable instantaneous forward rates for the obligor and the (market-implied) loss given defaults for the relevant time intervals.³⁷

In order to illustrate that only a distinct subset of pricing parameters are relevant for the determination of the capital charge we also introduce some “other” spread. For our calculation we use the market value of the bond and the deposit as the starting point. So this other spread is relevant for calculation in that we use it to determine the notional amounts which are provided for illustration. It is *not* relevant for the determination of the capital charge.

	Deposit (liability)	Bond (asset)
market value	USD 100 million (BRL 172 million)	GBP 62 million (BRL 172 million)
maturity	9 months	6 years
default-free instantaneous forward rates:		
up to 1 year	1%	2%
1 to 4 years		2.5%
above 4 years		3%
defaultable instantaneous forward rate for the obligor	4%	2%
(market-implied) loss given default	50%	50%
other spread	0.5%	0.7%
notional amount	USD 102.66 million	GBP 80.17 million

For simplicity we assume only for “the” forward rates, i.e. the default-free instantaneous forward rates, that they by time interval.

The market value of the deposit can be written as:

³⁷ For our calculation actually only the credit spreads for the relevant time intervals are needed, i.e. the product of the defaultable instantaneous forward rates for the obligor and the (market-implied) loss given defaults.

Seite 67 | 76

USD 100 million = $\exp(-0.9*(0.01+0.04*0.5+0.005))$ * USD 102.66 million. The market value of bond (which is a zero-coupon bond) can be written in an analogous way.

For the remainder of the example we will drop the „million“.

Step 1:

The value of both instruments is already expressed as a function of the pricing parameters that are shocked by the regulatory risk factors as in particular the forward rates refer to the same time intervals as the risk factors for interest risk at levels III and IV of the hierarchy. Therefore no further mapping is needed.

The applicable risk factors are:

Foreign exchange risk

Level	Deposit (liability)	Bond (asset)
I	exchange rate of BRL / worldwide currency basket	exchange rate of BRL / worldwide currency basket
II	exchange rate of worldwide currency basket / USD	exchange rate of worldwide currency basket / GBP

For foreign exchange risk all risk factors are hedgeable. The instruments have the risk factor at level I in common (“shock to exchange rate of BRL / worldwide currency basket”). This risk factor permits to recognise that a USD liability may provide a partial hedge to a GBP asset.

Interest rate risk

Level	Deposit (liability)	Bond (asset)
I	worldwide interest rate index	worldwide interest rate index
II	level of money market/swap rate curve in USD (residual)	level of money market/swap rate curve in GBP (residual)
III	slope of money market/swap rate curve USD (residual)	slope of money market/swap rate curve GBP (residual)
IV	money market/swap rate USD for forward rate between 0 and 1 year (residual)	money market/swap rate GBP for forward rate between 0 and 1 year (residual)
IV		money market/swap rate GBP for forward rate between 1 and 4 years (residual)
IV		money market/swap rate for forward rate GBP above 4 years (residual)
n-h	money market/swap rate USD for forward rate between 0 and 1 year (residual)	money market/swap rate GBP for forward rate between 0 and 1 year (residual)
n-h		money market/swap rate GBP for forward rate between 1 and 4 years (residual)
n-h		money market/swap rate for forward rate GBP above 4 years (residual)

The only risk factor for interest rate risk that both instruments have in common is the shock to the worldwide interest rate index. This risk factor permits to recognise that USD rates may provide a partial hedge to GBP rates for a BRL-based bank.

Credit spread risk

Level	Deposit (liability)	Bond (asset)
I	-	worldwide credit spread index
II	-	credit spread index by industry category (residual)
III	-	credit spread for the individual issuer (residual)
n-h	-	credit spread for the individual issuer (residual)

For credit spread risk there are no risk factors for the deposit as shocks to the bank's own credit risk would not be considered for the credit spread risk charge.

The non-hedgeable risk factor for the bond reflects issue-related credit spread risk.

For default risk there are no risk factors at all as the capital charge would be adapted from the banking book treatment.

The "other" spread is not relevant for the calculation of the capital charge. In the example the risks from a change to this "other" spread are captured by the non-hedgeable risk factors for interest rate risk and credit spread risk.

Seite 70 | 76

Step 2:

The sizes of the gross and net risk positions from the risk factors for foreign exchange risk are:

Foreign exchange risk: gross risk positions

Level	Deposit (liability)	Size of gross risk position	Bond (asset)	size of gross risk position
I	exchange rate of BRL/ worldwide currency basket	BRL -172	exchange rate of BRL / worldwide currency basket	BRL 172
II	exchange rate of worldwide currency basket / USD	BRL -172	exchange rate of worldwide currency basket / GBP	BRL 172

The size of the gross risk position is the signed market value of the respective instrument, expressed in reporting currency.

Foreign exchange risk: net risk positions

Level	risk factor	size of net risk position
I	exchange rate of BRL/ worldwide currency basket	BRL 0
II	exchange rate of worldwide currency basket / USD	BRL -172
II	exchange rate of worldwide currency basket / GBP	BRL 172

The size of the net risk position with respect to the risk factor “shock to exchange rate of BRL/ worldwide currency basket” is zero. This recognises that a GBP-denominated asset may provide a partial hedge against a USD-denominated liability to a BRL-based bank.

Interest rate risk: gross risk positions

Level	Deposit (liability)	Size of gross risk position	Bond (asset)	Size of gross risk position
I	worldwide interest rate index	BRL 1.548	worldwide interest rate index	BRL -26.660
II	level of money market/swap rate curve in USD (residual)	BRL 1.548	level of money market/swap rate curve in GBP (residual)	BRL -26.660
III	slope of money market/swap rate curve USD (residual)	BRL -1.548	slope of money market/swap rate curve GBP (residual)	BRL -6.880
IV	money market/swap rate USD for forward rate between 0 and 1 year (residual)	BRL 1.548	money market/swap rate GBP for forward rate between 0 and 1 year (residual)	BRL -3.440
IV			money market/swap rate GBP for forward rate between 1 and 4 years (residual)	BRL -12.900
IV			money market/swap rate for forward rate GBP above 4 years (residual)	BRL -10.320
n-h	money market/swap rate USD for forward rate between 0 and 1 year (residual)	BRL 1.548	money market/swap rate GBP for forward rate between 0 and 1 year (residual)	BRL -3.440

n-h			money market/swap rate GBP for forward rate between 1 and 4 years (residual)	BRL -12.900
n-h			money market/swap rate for forward rate GBP above 4 years (residual)	BRL -10.320

The size of the gross risk position from the bond (asset) with respect to the risk factor "shock to worldwide interest index" is determined as $BRL -26.660 = BRL -172 * (0.02 * 1 + 0.025 * 3 + 0.03 * 2)$.

The sizes of the gross risk positions from the deposit are small. This is due to the short maturity of 9 months, but also to the low interest rate of 1%. As mentioned earlier, certain pricing parameters (e.g., interest rates, credit spreads) could be subject to a floor, or the rules could fix them at a certain level for the determination of the capital charge.

Interest rate risk: net risk positions

Level	risk factor	size of net risk position
I	worldwide interest rate index	BRL -25.112
II	level of money market/swap rate curve in USD (residual)	BRL 1.548
II	level of money market/swap rate curve in GBP (residual)	BRL -26.660
III	slope of money market/swap rate curve USD (residual)	BRL -1.548
III	slope of money market/swap rate curve GBP (residual)	BRL -6.880
IV	money market/swap rate USD for forward rate between 0 and 1 year (residual)	BRL -3.440
IV	money market/swap rate GBP for forward rate between 0 and 1 year (residual)	BRL 1.548
IV	money market/swap rate GBP for forward rate between 1 and 4 years (residual)	BRL -12.900
IV	money market/swap rate for forward rate GBP above 4 years (residual)	BRL -10.320
n-h	money market/swap rate USD for forward rate between 0 and 1 year (residual)	BRL 1.548
n-h	money market/swap rate GBP for forward rate between 0 and 1 year (residual)	BRL -3.440
n-h	money market/swap rate GBP for forward rate between 1 and 4 years (residual)	BRL -12.900
n-h	money market/swap rate for forward rate GBP above 4 years (residual)	BRL -10.320

Seite 74 | 76

Hedging is recognised with respect to the risk factor "shock to worldwide interest rate index" (level I) only.

Credit spread risk: gross and net risk positions

Level	risk factor	Size of gross and net risk position
I	worldwide credit spread index	BRL -10.320
II	credit spread index by industry category (residual)	BRL -10.320
III	credit spread for the individual issuer (residual)	BRL -10.320
n-h	credit spread for the individual issuer (residual)	BRL -10.320

All risk factors apply to the bond (asset) as the credit spread risk from the liabilities is not reflected for the capital charge. The size of the risk position is determined as $BRL -10.320 = BRL -172 \cdot (0.01 \cdot 6)$.

Step 3:

Assuming a standard deviation of 10% for all risk factors and a scalar of 4 for the expected shortfall, the capital charge for foreign exchange risk is:

Foreign exchange risk

portfolio variance (BRL ²) (b)	591.680
portfolio standard deviation (BRL) (c)	24.324
expected shortfall (BRL) (d)	97.298

The computation under step 3 is analogous to the one in Example 1.

Seite 75 | 76

Assuming again a standard deviation of 10% for all risk factors and a scalar of 4 for the expected shortfall, the capital charge for interest rate risk is:

Interest rate risk	
portfolio variance (BRL ²) (b)	19.678
portfolio standard deviation (BRL) (c)	4.436
expected shortfall (BRL) (d)	17.744

The computation is again analogous to the one in Example 1.

The capital charge for **credit spread risk** is not included in this calculation as distributional assumptions would reflect skewness. The capital charge would be determined similarly to the risk from the underlying of the option in Example 1a.

For the bond, there would also be a capital charge for pure **default risk**. Based on the current rules for the standardised approach for credit risk and the external rating of British government debt, the capital charge would be zero.

Again, in order to determine the bank's capital charge for market risk, the capital charges for foreign exchange risk, for interest rate risk and credit spread risk would have to be combined according to a variant of the aggregation scheme of the models-based approach (see formula (1) in section 4.5.6 of the CP).

Example 2a: Hedging with a cross currency swap

The currency swap hedges the bank's risk positions for foreign exchange risk and interest rate risk with respect to all hedgeable risk factors. For foreign exchange risks the swap adds two non-hedgeable risk factors:

- "shock to exchange rate of worldwide currency basket / USD", and
- "shock to exchange rate of worldwide currency basket / GBP".

For interest rate risk, the swap adds four non-hedgeable risk factors:

- "shock to money market/swap rate USD for forward rate between 0 and 1 year (residual)"

Seite 76 | 76

- "shock to money market/swap rate GBP for forward rate between 0 and 1 year (residual)"
- "money market/swap rate GBP for forward rate between 1 and 4 years (residual)"
- "money market/swap rate for forward rate GBP above 4 years (residual)"

Note that such non-hedgeable risk factors had already been created for the deposit and the bond. The above further risk factors for the cross-currency swap are separate from those, i.e. they make their individual contribution to the portfolio variance. As the cross currency swap is a plain vanilla product with a maturity as long as five years, low standard deviations (risk weights) would apply to the additional non-hedgeable risk factors (just as to non-hedgeable risk factors for the interest rate risk from the deposit and the bond).

The counterparty credit risk and the risk of change to the credit value adjustment (CVA risk) of the swap would be capitalised according to Basel III.

In summary, the credit risk from the bond would not be changed by the swap. The swap would set the hedgeable FX and interest rate risk to zero, but the proposal would recognise basis risk through additional non-hedgeable risk factors.